

# audison

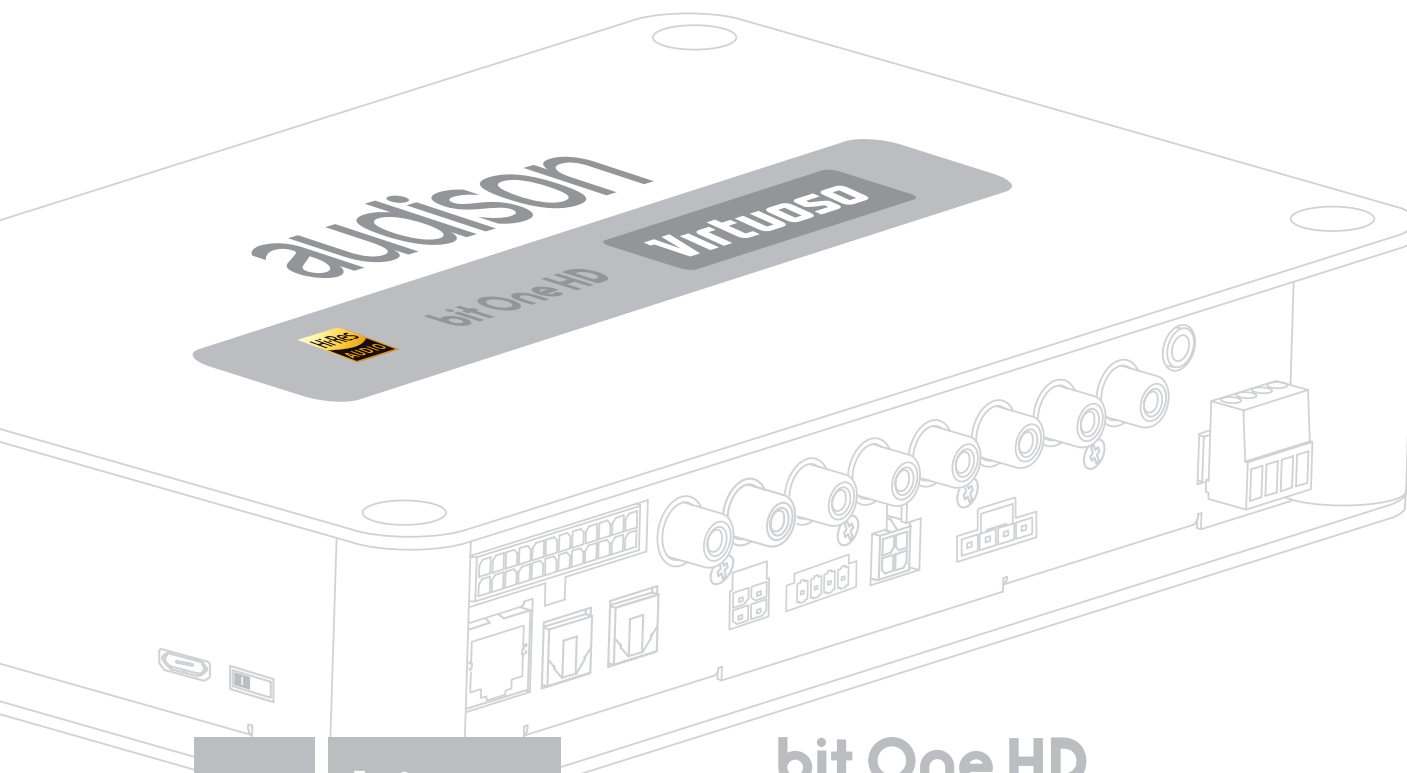

ideato,  
progettato,  
costruito  
in Italia



bit

bit One HD

# ***Virtuoso***

High Definition Signal Processor

# USER'S MANUAL

rev. 3.3



audison.com

# BIT GLOSSARY



Audison proprietary technology that allow pure digital signal transfer from source to amplifier with a resolution up to 24 bit/96 kHz.



bit Drive technology allow the communication with Audison bit Tune and bit Drive portal.



FLOATING POINT DSP

Analogue Device SHARC™ series chip with floating point precision, to reach the highest audio quality.



Virtuoso 3.0 FIR mode operation allows the user to process up to 9 digital channels with crossover FIR filters and equalizer. This sound processing mode, much more demanding in terms of calculation resources, ensures a leading edge in-car listening experience.



According to the definition of Hi-Res audio provided by JAS (Japan Audio Society - jas-audio.or.jp), Virtuoso 3.0 meets 24 bit / 96 kHz native processing requirement.



Virtuoso 3.0 RVA (Remote Volume Aux) provides the ability to select an auxiliary source (i.e.: a Hi-Res audio player or auxiliary wireless interface connected by digital inputs) and adjust its volume via the OEM Head Unit, offering full support to the management of the car priority signals while music is played through the auxiliary source.



Virtuoso 3.0 features a built-in RTA with target curve support (display, creation, importing) and correction file support. It can use your USB mic or USB sound card, or the bit Tune (but bit Tune is not required). Mic correction files can be imported.



Virtuoso 3.0 MPC technology provides the ability to deliver precision tuned systems for one or two seats (overall), correcting phase and amplitude, automatically. MPC is powered by Percept® algorithm, developed specifically for mobile, that use FIR filter computation performed by Virtuoso 3.0 SHARC DSP chip, and the bit Tune - upgraded to 3.0 level - to measure the impulse response of the system in the vehicle cabin.



Virtuoso 3.0 MAC technology provides the ability to perform auto equalization correction based on the signal amplitude using an RTA measurement and a selected target curve without using bit Tune.



USS technology allows Virtuoso 3.0 to work with head-units featuring the "speaker load detection" circuit.



Automatic De-equalization algorithm to "flatten" any equalization applied by default by OEM sources.



Automatic De-time algorithm to compensate time-delayed factory outputs prior to signal summing.



Automatic De-phase algorithm to compensate the overall system phase restoring original signal, even in case of OEM sound enhancement algorithms.



High level inputs polarity check and automatic correction in case of inversion



Virtuoso 3.0 I/O routing approach dedicated to OEM sound system (hi-level), based on "pass-through" the existing OEM infotainment's output channels.



Virtuoso 3.0 I/O routing approach based on signal summing, signal reconditioning & flattening. With this setup mode, automatic algorithm options named DE-EQ / DE-Phase, DE-TA, Polarity check and Auto Input Switch can be selected.



Virtuoso 3.0 Parametric EQ mode allows users to control both amplitude, center frequency and bandwidth for each of 11 poles available. Parametric EQ poles are capable of making precise adjustments to sound and are commonly used in sound recording and live sound reinforcement.



Virtuoso 3.0 Graphic EQ mode allow user to adjust amplitude for each of the 31 bands (1/3-octave equalizer) available using a slide control to boost or cut frequency components passed by that filter.



Virtuoso 3.0 signal-driven option to Dynamic EQ allow equalization curve to be controlled by OEM volume control position, rather than only by DRC volume knob.

# Index

<b>1. PRODUCT DESCRIPTION</b> .....	4
<b>2. PACKAGING CONTENTS</b> .....	4
<b>3. bit One HD Virtuoso AND DRC MP INSTALLATION</b> .....	5
<b>4. CONNECTION PANELS - DESCRIPTION</b> .....	6
4.1 INPUT SIGNALS.....	6
4.2 OUTPUT SIGNALS.....	8
4.3 INPUTS - REMOTE CONTROL OUTPUTS AND POWER SUPPLY.....	9
<b>5. CONNECTIONS</b> .....	11
5.1 POWER SUPPLY AND REMOTE TURN ON.....	11
5.2 HOW TO TURN THE bit One HD Virtuoso ON/OFF.....	11
5.3 PERSONAL COMPUTER and DIGITAL REMOTE CONTROL (DRC MP).....	11
5.4 LOW-LEVEL AND DIGITAL INPUT SIGNALS.....	12
5.4.1 PRE IN - CH1/CH6 ANALOG STEREO SIGNAL.....	12
5.4.2 AUX - LEFT/RIGHT - ANALOG STEREO SIGNAL.....	12
5.4.3 "AUTO INPUT SWITCH" AUX SIGNAL.....	12
5.5 HIGH-LEVEL INPUT SIGNALS.....	13
5.5.1 SPEAKER IN HI-LEVEL MULTICHANNEL (MAX 12 CHANNELS).....	13
5.6 OPTICAL 1/OPTICAL 2 DIGITAL INPUT SIGNALS.....	13
5.6.1 "OPTICAL 1" AUDIO DETECT.....	14
5.6.2 "OPTICAL 2" SDC DETECT + B-CON.....	14
5.6.3 "AUTO INPUT SWITCH" OPTICAL 1 / OPTICAL 2 SIGNALS.....	15
5.7 OUTPUT SIGNALS.....	16
5.7.1 OUTPUT TO AN AMPLIFIERS SYSTEM PROVIDED WITH AD LINK AND AC LINK CONNECTION.....	16
5.7.2 OUTPUT TO AN AMPLIFIERS SYSTEM WITH PRE INPUT.....	17
5.7.3 OUTPUT TO AN AMPLIFIERS SYSTEM PROVIDED WITH AD LINK AND AC LINK CONNECTIONS (THESES TH) AND AMPLIFIERS PROVIDED WITH PRE INPUT.....	17
<b>6. bit One HD Virtuoso SOFTWARE AND DRIVERS - INSTALLATION GUIDE</b> .....	18
6.1 SOFTWARE INSTALLATION GUIDE.....	18
6.2 DRIVERS INSTALLATION GUIDE FOR WINDOWS VISTA, 7/8/10.....	20
6.3 bit One HD Virtuoso SOFTWARE UNINSTALL.....	20
<b>7. bit One HD Virtuoso SETUP WITH PC</b> .....	21
7.1 OFFLINE MODE IIR/FIR.....	21
7.2 CONNECT MODE.....	23
7.2.1 I/O CONFIGURATION WIZARD.....	25
7.2.2 AUTOMATIC ROUTING.....	26
7.2.3 PASS THROUGH.....	37
7.2.4 MASTER INPUT OPTICAL 1.....	45
<b>8. bit One HD Virtuoso SETUP USING A PC</b> .....	49
8.1 FEATURES.....	49
8.2 MAIN MENU: "FILE".....	50
8.3 MAIN MENU' "CONFIG".....	52
8.4 MEMORY.....	56
8.5 SELECT A CHANNEL / BATTERY STATUS.....	57
8.6 CHANNEL MAP.....	58
8.7 FILTER SETTINGS / DELAY.....	59
8.7.1 FILTER SETTINGS.....	59
8.7.2 SET DISTANCE AND DELAY.....	62
8.8 EQ SETTINGS.....	65
8.8.1 PARAMETRIC/GRAPHIC INPUT EQ.....	66
8.8.2 CHANNELS AND FRONT EQUALIZER.....	71
8.8.3 MAIN EQ.....	79
8.8.4 RTA.....	80
8.9 OUTPUT LEVEL.....	82
8.10 VOLUME LEVEL.....	83
8.11 SELECT INPUT.....	83
8.12 SETUP.....	84
8.13 DEVICE INFO.....	89
<b>9. TROUBLESHOOTING</b> .....	90
9.1 SYNCHRONIZATION WITH THE PC.....	90
9.2 BACKGROUND NOISE.....	90
9.3 FIRMWARE UPDATE.....	90
9.4 RESCUE MODE.....	92
<b>10. TECHNICAL SPECIFICATIONS</b> .....	94
<b>11. ADDENDUM</b> .....	95
11.1 USE OF THE KEYBOARD TO ADJUST THE BIT ONE HD SETTINGS.....	95
11.2 ACOUSTICS RTA VIA bit Tune.....	97

## 1. PRODUCT DESCRIPTION













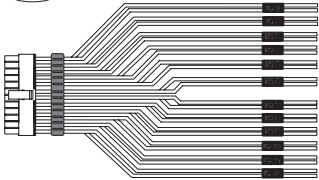

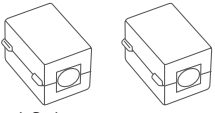
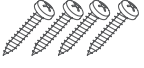

The bit One HD Virtuoso is a digital signal processor developed to obtain outstanding performance from car audio systems.

The main features include 2 optical SP/DIF inputs, 12 analog inputs, 13 digital outputs and Hi-Res 24bit/96kHz internal signal processing which, along with many other functions make it a powerful and versatile product, ready for future evolutions.

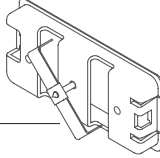
To this end, several hardware updates have already been planned. These updates will enable the product to adapt to future technological innovations, providing the ability of interfacing with OEM systems which, at the time of the product conception, were merely hypothetical.

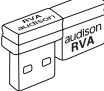
The all-round software and the endless dedication of the R&D team, aimed at improving and updating the product, make the bit One HD Virtuoso the reference device on the market, keeping its leadership for many years to come and rewarding the user with the quality of its sound and with a long-lasting investment.

## 2. PACKAGING CONTENTS

- **bit One HD Virtuoso** - Signal Interface Processor 
- **DRC MP** (Digital Remote Control) Control Panel 
- Multipolar cable, Speakers Input: 
- Multipolar cable, Controls 
- **RVA cable** 4.5 m 
- **Jack/RCA Stereo Adapter** 
- **N.2 x 5.0 m / 196,85" AC Link (RJ-12) cable** 
- **N.2 x 5.0 m / 196,85" AD Link (LAN class 5S - RJ45) cable** 
- **1.8 m / 70,8661" USB cable:** 
- **N.2 EMC Ferrite filters.** 
- **N. 4 4,2 x 32 mm self-tapping, cross-head fixing screws** 
- **4.5 m / 177,16" DRC / AC Link cable** 
- **N. DRC MP holder Kit.** 
- **USB Dongle Setup:**   
 bit One HD Virtuoso software  
 This User's Manual (.pdf)  
 Test audio tracks, stereo decoding and 5.1 Dolby Digital
- **USB RVA:**   
 RVA setup tracks
- **Quick Start Guide bit One HD Virtuoso** 
- **Quick Start Guide DRC MP** 
- **Warranty** 

**WARNING:** a PC provided with Windows Vista, Windows 7 or Windows 8, operating system, 1.5 GHz minimum processor speed and 1 GB RAM minimum memory, is required to install the software and setup the bit One HD Virtuoso.



### 3. bit One HD Virtuoso AND DRC MP INSTALLATION

#### bit One HD Virtuoso:

##### External dimensions



##### Mounting dimensions

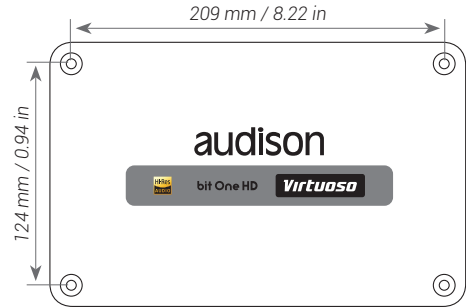

##### Fixing instructions

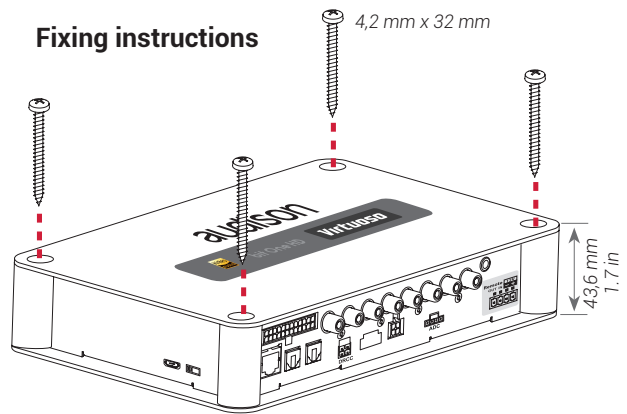

#### DRC MP:

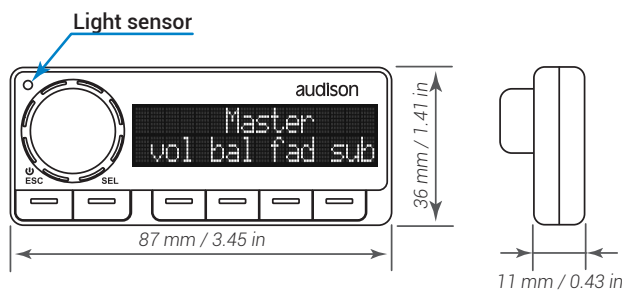

##### How to install the DRC MP

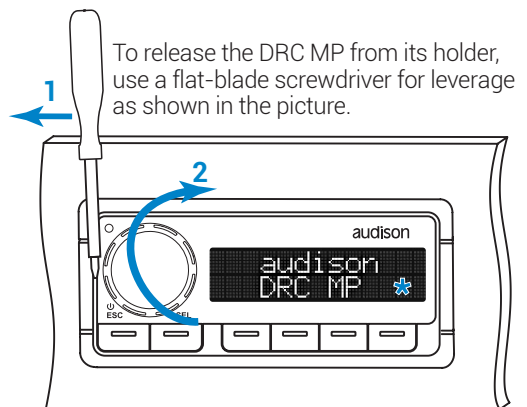
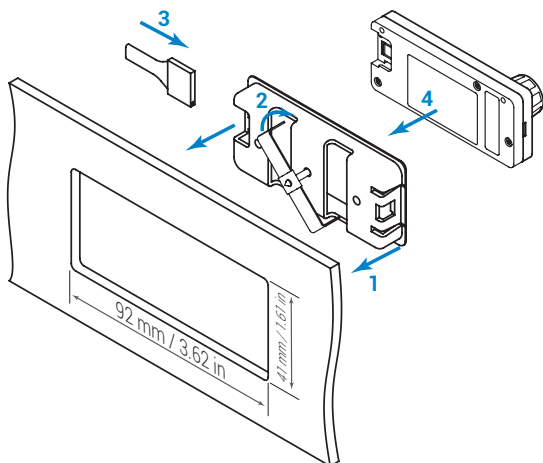

**\* WARNING** do not use aggressive cleaning agents or abrasive cloth to clean the display. Simply use a soft cotton cloth lightly damped with water.

## 4. CONNECTION PANELS - DESCRIPTION

### 4.1 INPUT SIGNALS

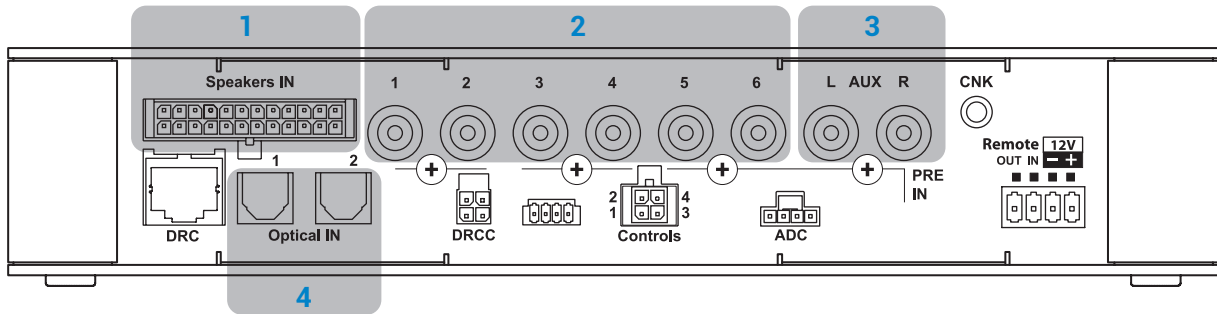

#### 1. SPEAKERS IN hi-level MASTER input [\(see section 5.5\)](#)

**Ch1 - Ch2 - Ch3 - Ch4 - Ch5 - Ch6 - Ch7 - Ch8 - Ch9 - Ch10 - Ch11 - Ch12**

HI LEVEL MASTER inputs to connect the amplified signal wires coming from the main analog source. Input sensitivity automatically adjustable from 2 to 15 V RMS [\(see sec. 7.2.4\)](#).

Channels Ch1 - Ch2 feature the AUTO TURN ON (ART) function through the connection with the source speakers outputs. This function can be excluded using the PC software [\(see section 7.2.2.2\)](#).

The input signals are interfaced to the bit One HD Virtuoso via wiring with a multi-pin 24 poles connector as described below.

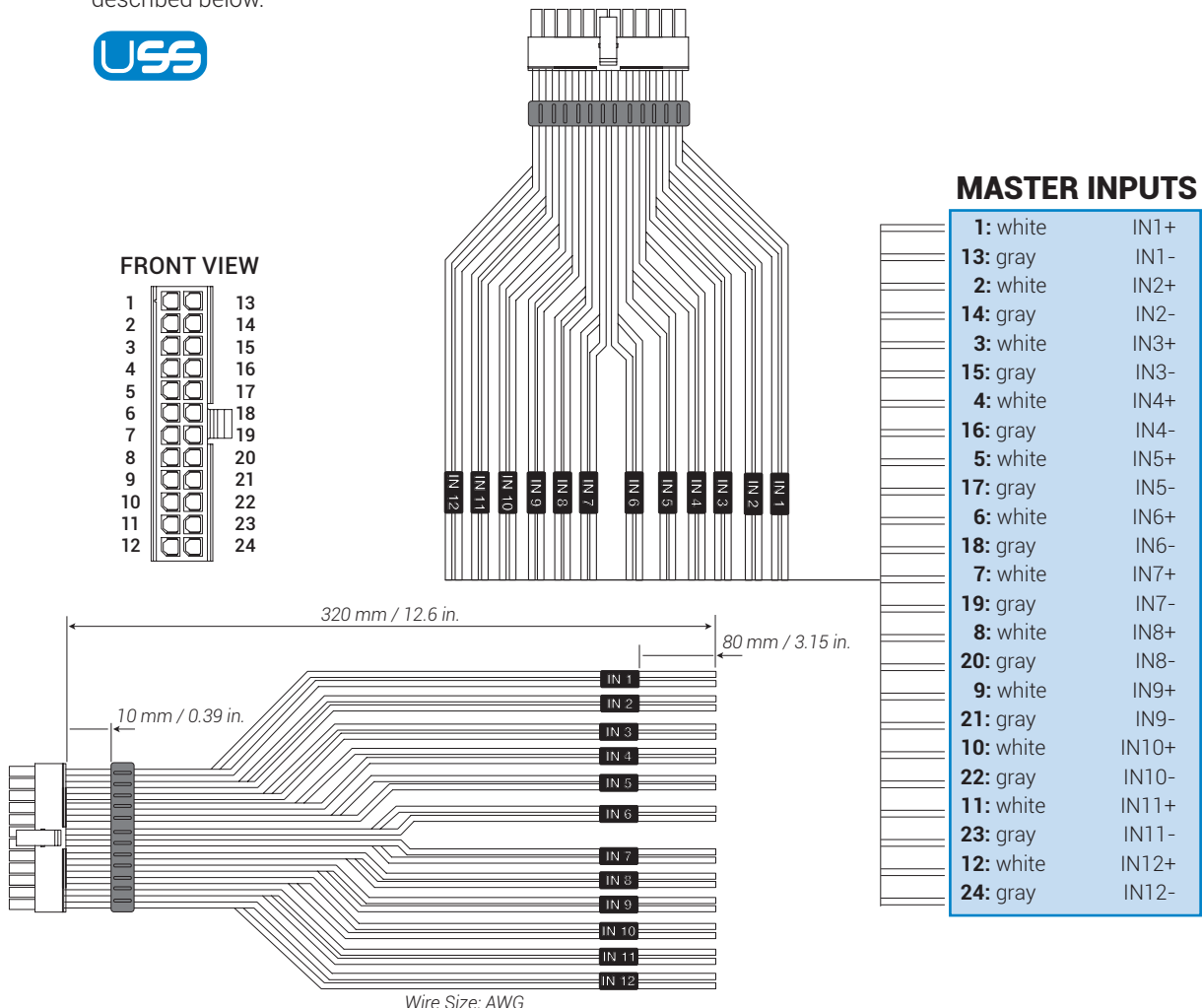

**Remark:** when connecting a speaker input cable, use Faston crimp terminals.

**2. PRE IN low-level MASTER inputs** ([see section 5.4.1](#))

**Ch1 - Ch2 - Ch3 - Ch4 - Ch5 - Ch6**

To connect RCA cables coming from the main analog signal source.

If these inputs are used, the MASTER SPEAKER IN inputs can not be used.

**3. AUX auxiliary low-level STEREO inputs** ([see section 5.4.2](#))

To connect the RCA cables coming from additional analog signal sources.

**4. OPTICAL IN digital inputs** ([see section 5.6](#))

**Bit One HD** accepts input PCM signals up to 192 kHz / 24 bit sampling frequency rate. So DOLBY DIGITAL (AC3) multi-channel signals coming from audio/video sources (such as the audio of a film in DVD) or DTS can not be reproduced. These inputs can be selected using the external DRC control or activated using the terminals ([see section 4.3.4](#)).

**OPTICAL 1.** Connect an optical fiber cable with TOSLINK connector

**OPTICAL 2.** Connect an optical fiber cable with TOSLINK connector

**Remark:** when performing the installation of fiber optic cables, the minimum bending radius should be 40 mm. A bending with higher radius value may cause the cable to break and the consequent disruption of the digital signal.

**4.2 OUTPUT SIGNALS**

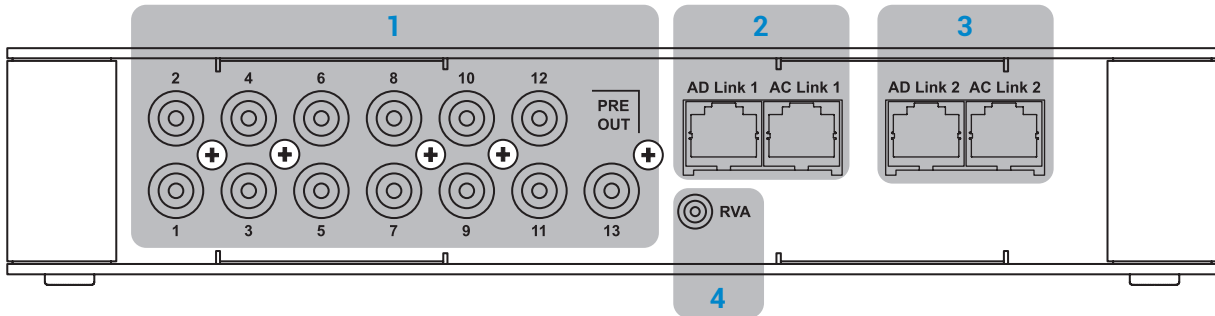

- 1. PRE OUT low-level analog signal (4 Volt RMS)** [\(see section 5.7.2\)](#)  
**Ch1 - Ch2 - Ch3 - Ch4 - Ch5 - Ch6 - Ch7 - Ch8 - Ch9 - Ch10 - Ch11 - Ch12 - Ch13**  
 To connect the RCA cables going to the system's amplifiers.
- 2. AD Link - OUT digital signal** [\(see section 5.7.1\)](#)  
 S/PDIF standard digital signal (Ch1÷Ch13) to connect amplifiers provided with the specific AD Link input.  
**AD LINK 1:** S/PDIF standard digital signal (Ch1÷Ch8) to connect amplifiers provided with the specific AD Link input  
**AD LINK 2:** S/PDIF standard digital signal (Ch9÷Ch13) to connect amplifiers provided with the specific AD Link input
- 3. AC Link:** Connection socket to control the amplifiers provided with AC Link connection [\(see section 5.7.1\)](#).  
**AC LINK 1:** Connection socket to control the amplifiers (Ch1÷Ch8) provided with AC Link connection.  
**AC LINK 2:** Connection socket to control the amplifiers (Ch9÷Ch13) provided with AC Link connection.

**Remark:** the Remote Out signal is available on the AC LINK 1 / AC LINK 2 connection plugs and is active to the amplifiers supporting this function (Audison AV amplifiers with AV bit IN input).

- 4. RVA (Remote Volume Aux):** control signal output to connect to the master source AUX input, to enable the "AIS - Auto Input Switch" function. [\(see 5.4.3 - 5.6.1, 8.3.5\)](#).

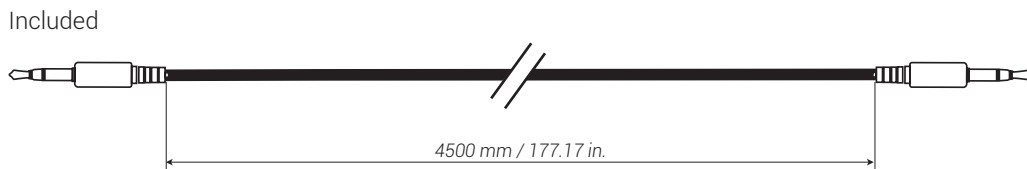

**4.3 INPUTS - REMOTE CONTROL OUTPUTS AND POWER SUPPLY**

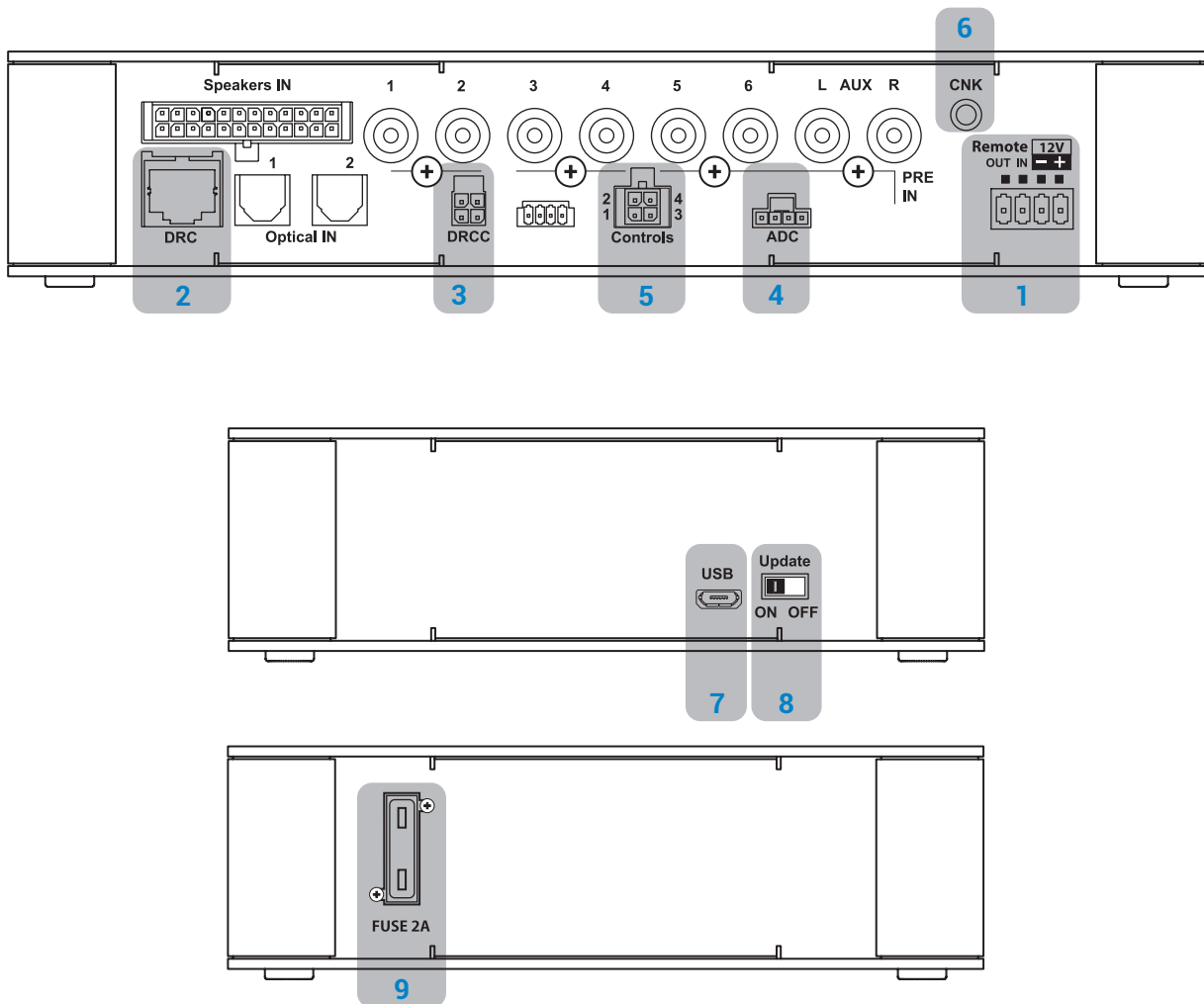

- 1. POWER SUPPLY / REMOTE IN-OUT** *(see section 5.1)*  
**+BATT 12V:** positive connection terminal for car 12V power supply  
**-BATT:** negative connection terminal for car 12V power supply.

**WARNING:** make sure the connection polarity is as indicated on the terminals. A misconnection may result in damage to the **bit One HD Virtuoso**. After applying a 12V power, wait at least 10 seconds before turning the **bit One HD Virtuoso** on.

**REMOTE IN:** for the processor remote turn-on through one or multiple signal sources, featuring Rem Out control.

**WARNING:** the **bit One HD Virtuoso** must be switched on before the amplifiers connected are turned on. It is necessary to connect the sources Remote Out to the **bit One HD Virtuoso** Remote In and then the **bit One HD Virtuoso** Remote Out to the Remote In of the other devices / amplifiers connected to the **bit One HD Virtuoso** *(section 5.1)*

**REMOTE OUT:** for the remote turn-on of the other devices/amplifiers connected to the processor. The REMOTE OUT output has a current capability of 130 mA (it can also drive an automotive relay). The processor only takes 7 seconds to supply the REM OUT to the output after turn on.

**Remark:** the Remote Out signal is available on the AC LINK 1 / AC LINK 2 connection plugs and is active to the amplifiers supporting this function (Audison AV amplifiers with AV bit IN input).

- 2. DRC:** connection plug for the DRC MP (Digital Remote Control), to control the processor's functions
- 3. DRCC:** terminals for future use.
- 4. ADC:** connection socket for devices equipped with serial communication (B-CON, W-CON), for volume adjustment and source change. The connection cable is supplied together with the interfaced accessory.

5. **CONTROLS:** Through the use of the "Controls" connector it is possible to electrically activate a series of commands from the outside. Mainly it allows the selection of the main inputs of the Virtuoso, and the automatic activation of an Overall memory, specially set up for multi-point listening in the car passenger compartment. The control signals are interfaced with the **bit One HD Virtuoso** by means of a wiring with 4-pole multipolar connector described below.

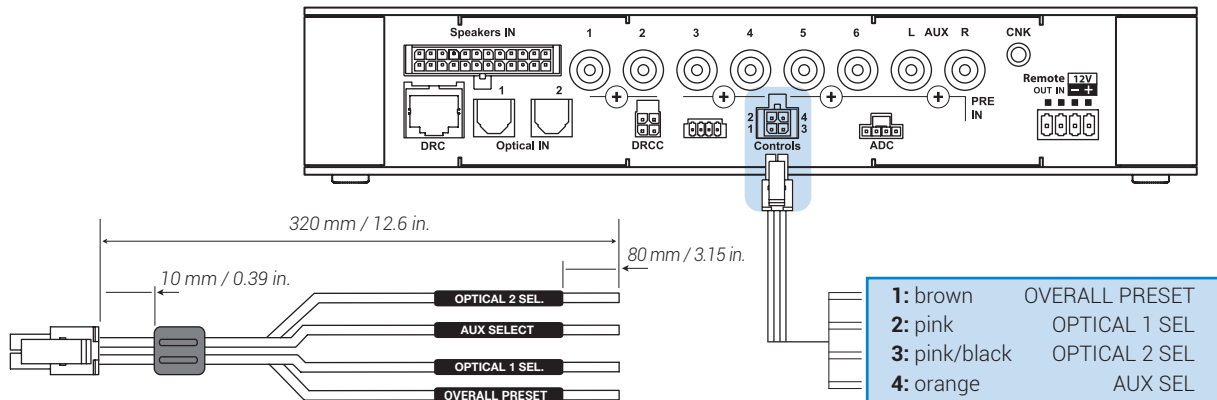

- **OVERALL PRESET:** allows the selection of a memory of the bit One HD Virtuoso previously saved via PC software (see section 8.4). This command is activated by connecting the terminal to + 12V.

We recommend using the UOS accessory for the automatic switching of the Overall memory. Use the connection diagram below, making sure that the changeover mat is correctly installed in the seat of your car. This can be easily installed between the seat padding and the cover ensuring safe and reliable switching.

**Remark:** the installation of this device must be carried out by an expert.

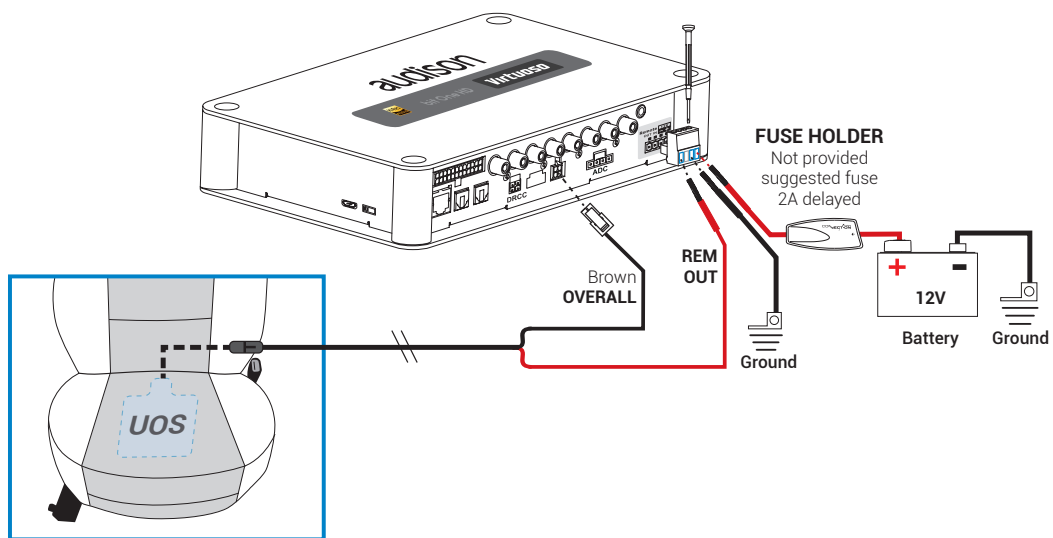

- **OPTICAL 1 SELECT:** selection of the **OPTICAL 1** input. This function is activated by connecting the terminal to + 12V.

- **OPTICAL 2 SELECT:** selection of the **OPTICAL 2** input. This function is activated by connecting the terminal to + 12V.

- **AUX SELECT:** selection of the analog **AUX** input. This function is activated by connecting the terminal to + 12V. The control signals are interfaced to the bit One HD Virtuoso via wiring with a multi-pin 4 poles connector as described below.

6. **CNK:** terminals for future use.

7. **USB** (section 5.3)

USB connection plug (Female type micro), to connect the processor to a PC and manage its functions through the **bit One HD Virtuoso** software. The standard connection is USB 1.1/2.0/3.0 compatible.

8. **UPDATE MODE: Switch ON** enables the update in **RESCUE MODE** (section 9.4) and the **bit One HD Virtuoso** logo will start flashing.

9. **FUSE:** Blade 2A protection fuse. When needing to replace the fuse, only use the same type and value as the original.

## 5. CONNECTIONS

### 5.1 POWER SUPPLY AND REMOTE TURN ON

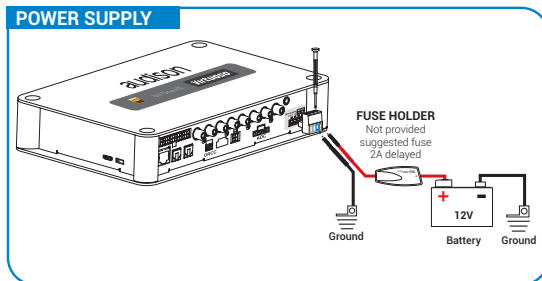

**WARNING:** to power the **bit One HD Virtuoso**, use 1 mm<sup>2</sup> (16 AWG) min. cables

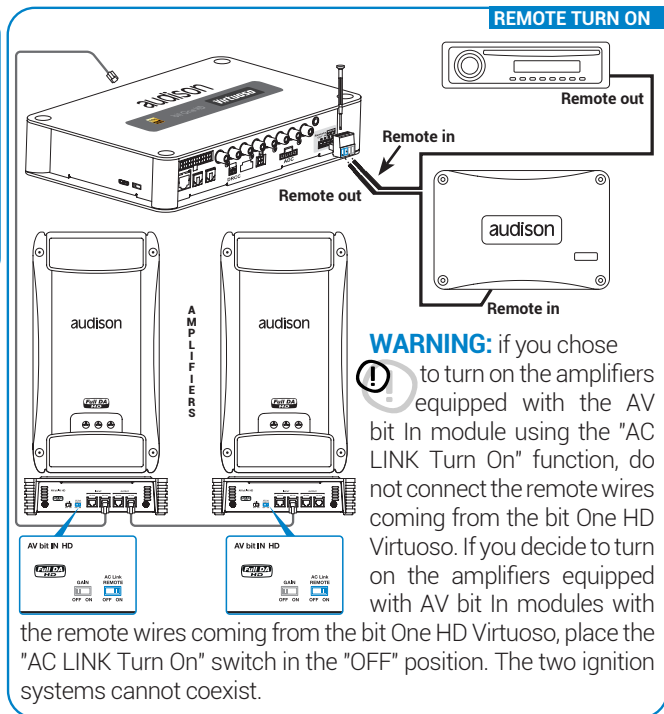

### 5.2 HOW TO TURN THE bit One HD Virtuoso ON/OFF

The **bit One HD Virtuoso** is on when the Audison logo lights up in blue.

After receiving the turn on input the bit One HD Virtuoso takes 6 seconds to start working. It can be turned on / off in the following ways:

1. Through the **DRC MP** main control switch (to turn on). Keep the **DRC MP** main control knob pressed (to shut down). In this case no other Remote In connections are required, but they can coexist ([see section 5.1](#)).
2. By connecting the REMOTE IN terminal with a Remote Out signal coming from an after-market audio source.
3. Through the **SPEAKER IN CH1-CH2**. The **AUTO TURN ON (ART)** is activated by connecting the amplified head unit output to the **SPEAKER IN CH1-CH2** input channel. This function can be enabled/disabled using the **bit One HD Virtuoso** PC software ([see section 7.2.2.2](#)).

### 5.3 PERSONAL COMPUTER and DIGITAL REMOTE CONTROL (DRC MP)

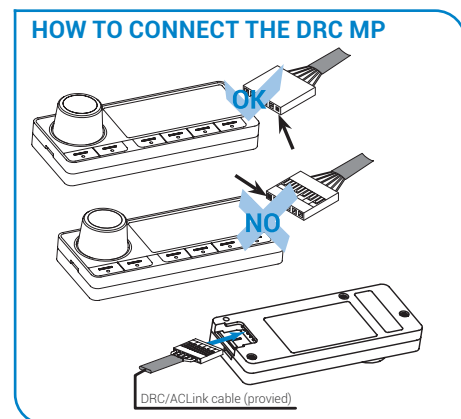
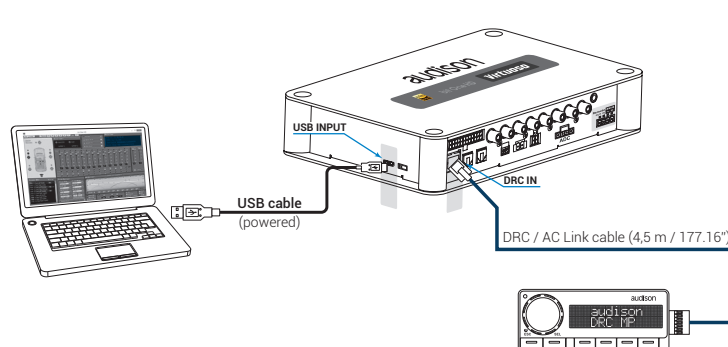

## 5.4 LOW-LEVEL AND DIGITAL INPUT SIGNALS

### 5.4.1. PRE IN - Ch1/Ch6 analog STEREO signal

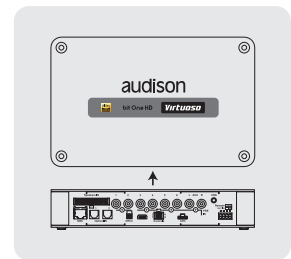
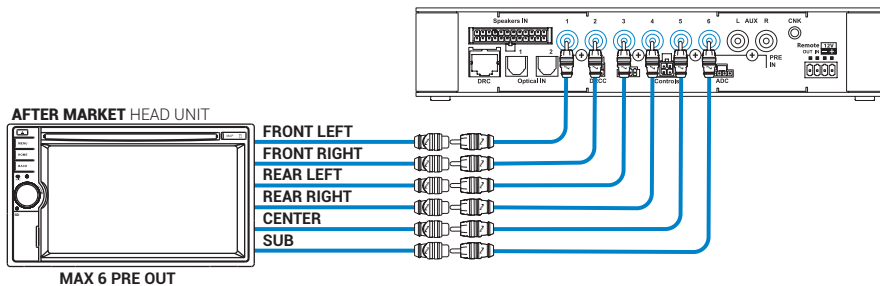

bit One HD Virtuoso  
Bottom Side

#### Selection of the MASTER PRE IN input

1. Through the **DRC MP**, selecting the **MASTER** input.
2. Through the **MASTER** input, using the **bit One HD Virtuoso** PC software

### 5.4.2. AUX - Left/Right - analog STEREO signal

#### Selection of the AUX IN input

1. Through the **DRC MP**, selecting the **AUX** input.
2. Through the **AUX SEL** terminal (see section 4.3.4). This control is enabled by connecting the terminal at + 12V.
3. Through the **bit One HD Virtuoso** PC software, selecting the **AUX** input.
4. Through the selection of the AUX input from the OEM source, using the "Auto Input Switch" function, via the bit One HD Virtuoso PC software (see section 5.4.3 - 7.2.4).

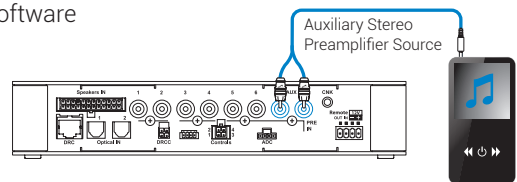

### 5.4.3. "AUTO INPUT SWITCH" AUX SIGNAL

Activate the **"AUTO INPUT SWITCH"** function on the AUX input via PC software to enable the bit One HD Virtuoso AUX input, each time the source AUX input is activated. When using this function the **bit One HD Virtuoso** volume can be controlled through the source volume (see section 7.2.4).

**Remark:** when activating the **"Auto Input Switch"** function, the DRC/PC Software can no longer be used for the selection of the audio system inputs. The switch can be enabled through the audio system source, selecting the AUX or Master input.

Connect the Head Unit AUX input to the **RVA** connector of the bit One HD Virtuoso as follows, using the wiring supplied in the giftbox.

The selection of the source AUX input will then allow the automatic selection of the bit One HD Virtuoso auxiliary input.

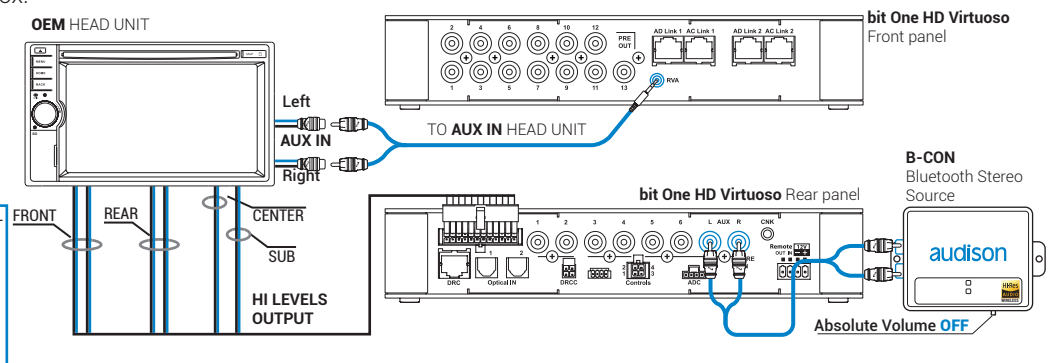

\*If the car HEAD UNIT does not feature an AUX analog input, connect the USB RVA device, supplied with the product, to the USB player of your audio source as shown to the side. The USB device contains the ready-to-use 16.5KHz.MP3 format file (default), but it is possible to choose one of the other tones included in the compressed folder during the calibration (see section 8.3.5).

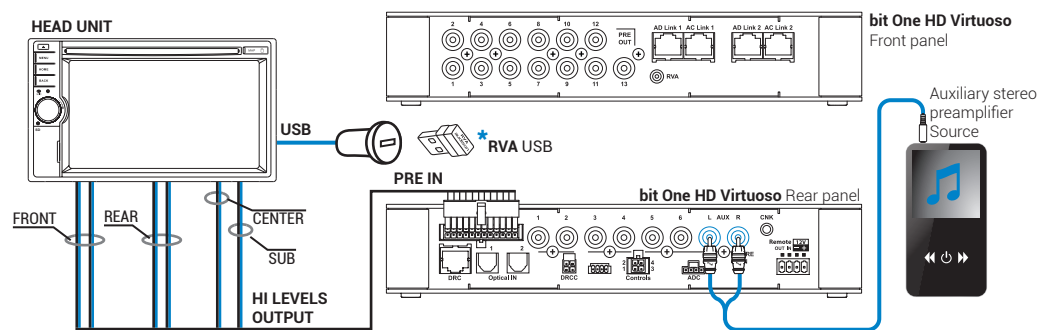

If a USB reader is not available, you can copy the tone to be used for automatic switching from the supplied USB RVA device to an SD Card type storage device.

Please note that the storage device must contain only this file and no other files. If you use the USB memory to activate the switching via the RVA function, just select the USB (SD) input of the main source (Head Unit).

## 5.5 HIGH-LEVEL INPUT SIGNALS

### 5.5.1. SPEAKER IN Hi-level MULTICHANNEL (max 12 CHANNELS)

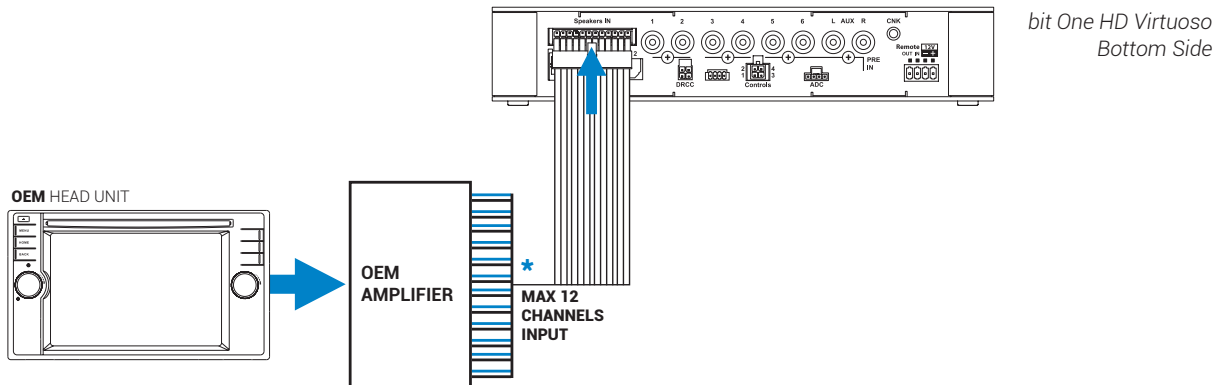

\* CH1-CH2: Auto Turn On System (ART) (see section 7.2.2)

#### MASTER SPEAKER IN input selection

1. Through the **DRC MP**, selecting the **MASTER** input.
2. Through the **MASTER** input, using the **bit One HD Virtuoso** PC software.

## 5.6 OPTICAL 1/OPTICAL 2 DIGITAL INPUT SIGNALS

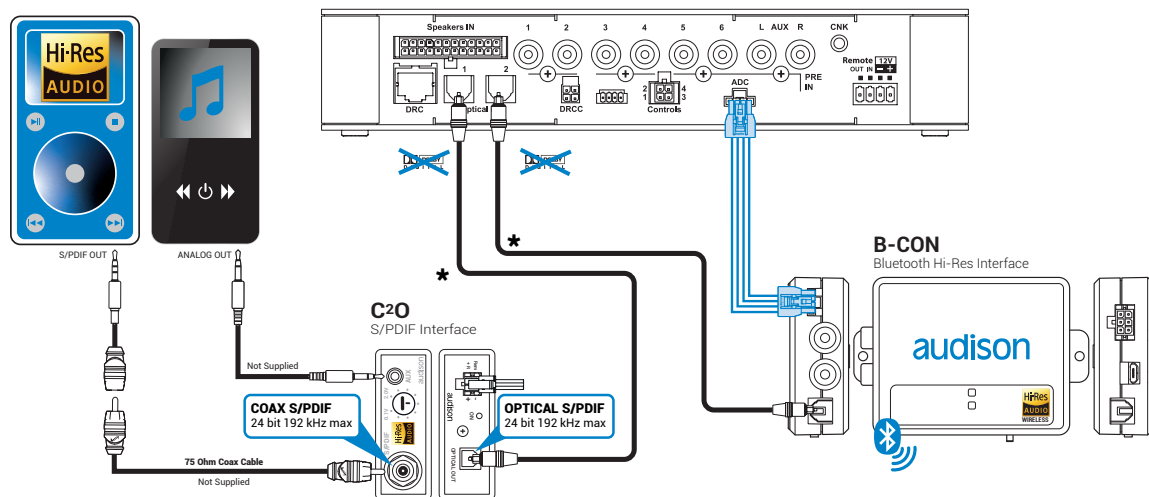

**WARNING:** the digital inputs accept up to 192 kHz / 24 bit stereo PCM signals. So DOLBY DIGITAL (AC3) multi-channel signals coming from audio/video sources (such as the audio of a film in DVD) or DTS can not be reproduced. The output of these devices will therefore be set in STEREO mode for the signal to be reproduced.

\* **Remark:** when performing the installation of fiber optic cables, the minimum bending radius should be 40 mm. A bending with higher radius value may cause the cable to break and the consequent disruption of the digital signal.

#### OPTICAL 1/OPTICAL 2 inputs selection

1. Through the **DRC MP**, selecting the **OPTICAL 1 / OPTICAL 2** input.
2. Through the OPTICAL 1 SEL / OPTICAL 2 SEL terminal properly set up (see section 4.3.4). This control is activated by connecting the terminal at + 12V.
3. Through the selection of the OPTICAL 1/ OPTICAL 2 input via the **bit One HD Virtuoso** PC software.
4. Through the selection of the OPTICAL 1/ OPTICAL 2 input on the OEM source, using the "Auto Input Switch" function, via the **bit One HD Virtuoso** PC software (see section 5.6.1 - 7.2.4).

### 5.6.1. OPTICAL 1 / OPTICAL 2 AUDIO DETECT.

By activating the "Optical 1 / Optical 2 Audio INPUT SWITCH" function from the PC software, it is possible to automatically activate the OPTICAL 1 or Optical 2 input of the bit One HD Virtuoso, whenever an audio signal is present. Activate the function using the menu as described in section [see section 8.3.6](#).

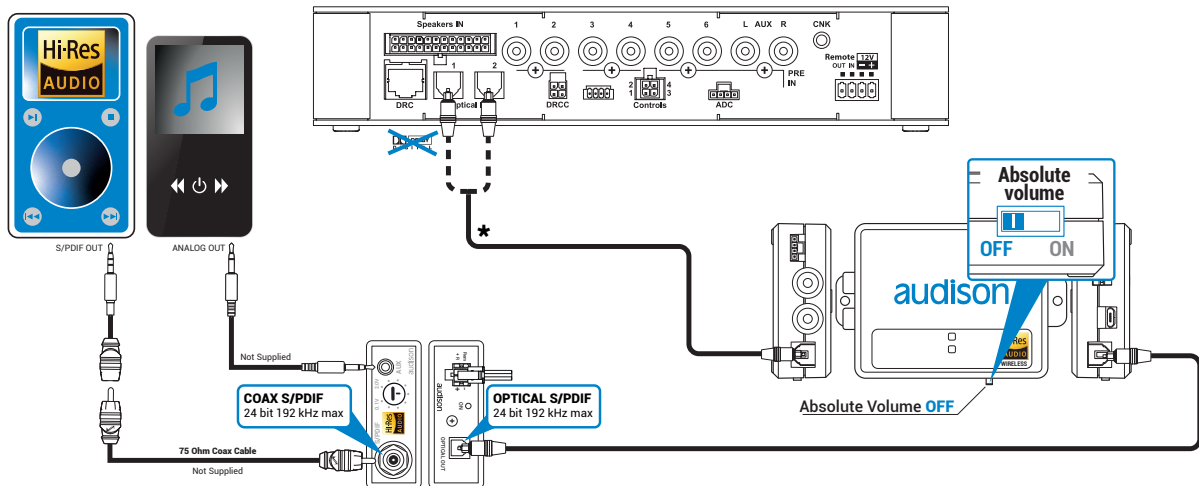

\*Connect the OPTICAL 1 or OPTICAL 2 input of the bit One HD Virtuoso to the digital audio source as follows. The Audio Detect function is available on one input at a time.

**WARNING:** the activation of the "Auto Input Switch" function, and the related selection of the auxiliary input to be used, leads to the loss of the other two auxiliary inputs not selected.

**Remark:** by activating the "Optical 1 / OPTICAL 2 Audio INPUT SWITCH" function, this will have priority over the other inputs of the bit one HD Virtuoso. Switching will take place when the audio signal is available on the OPTICAL 1 or OPTICAL 2 input. In this operating mode it is possible to control the volume through DRC MP volume, or directly from the digital source connected to the optical input selected.

The usability of the Optical 1 / Optical 2 inputs AUDIO DETECT depends on the use of the same inputs for other functions ([see section 8.3.6](#)).

### 5.6.2. OPTICAL 2 / SDC DETECT + B-CON

By connecting the optical output of the B-CON to the Optical 2 input of the bit One HD Virtuoso, it is possible to automatically switch the Optical input by using the connection between the SDC connector towards and the B-CON. When Bluetooth audio streaming starts, the B-CON device will automatically activate the Optical 2 input. In case of incoming calls via Bluetooth hands-free telephone or Bluetooth audio end streaming, the main Master input will be reactivated.

#### Absolute Volume.

This function, if enabled on the B-CON device, will allow you to adjust the main volume not only with the DRC MP, but also with the volume keys of the connected mobile device. If the Absolute volume function is not enabled on the B-Con it will be possible to adjust the main volume only with the DRC MP.

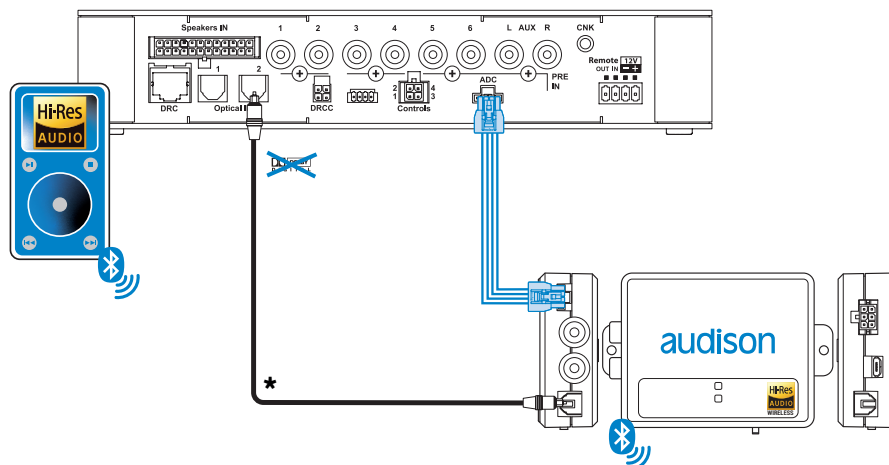

**5.6.3. "AUTO INPUT SWITCH RVA" OPTICAL 1 / OPTICAL 2 SIGNALS.**

Activate the "AUTO INPUT SWITCH" function on the **OPTICAL 1** or **OPTICAL 2** input via PC software to enable the **bit One HD Virtuoso** OPTICAL 1 / OPTICAL 2 input, each time the source AUX input is activated. When using this function the **bit One HD Virtuoso** volume can be controlled through the source volume (see section 7.2.4 - 8.3.5).

Connect the bit One HD Virtuoso OPTICAL 1, OPTICAL 2 input to the audio source and the processor's RVA input to the Master source AUX input (Head Unit).

**WARNING:** the "Auto Input Switch" function activation, and the subsequent selection of the auxiliary input to be used, may cause the loss of the other two auxiliary inputs not selected.



**Remark:** when activating the "Auto Input Switch" function, the DRC/PC Software can no longer be used for the switch of the audio system inputs.

The switch can be enabled through the audio system source, selecting the AUX or Master input.

When the "AIS - Auto Input Switch" function is active and a bit Play HD is connected to the system along with Full DA amplifiers (AD LINK - AC LINK) the DRC MP will be disabled and will display the following: "DRC DISABLED".

Connect the Head Unit AUX input to the RVA connector of the **bit One HD Virtuoso** as follows, using the wiring supplied in the giftbox.

The selection of the source AUX input will then allow the automatic selection of the **bit One HD Virtuoso** auxiliary input.

\* If the car HEAD UNIT does not feature an AUX analog input, connect the USB RVA device, supplied with the product, to the USB player of your audio source as shown to the side. The USB device contains the ready-to-use 16.5KHz.MP3 format file (default), but it is possible to choose one of the other tones included in the compressed folder during the calibration (see section 8.3.5).

If a USB reader is not available, you can copy the tone to be used for automatic switching from the supplied USB RVA device to an SD Card type storage device.

Please note that the storage device must contain only this file and no other files.

If you use the USB memory to activate the switching via the RVA function, just select the USB (SD) input of the main source (Head Unit).

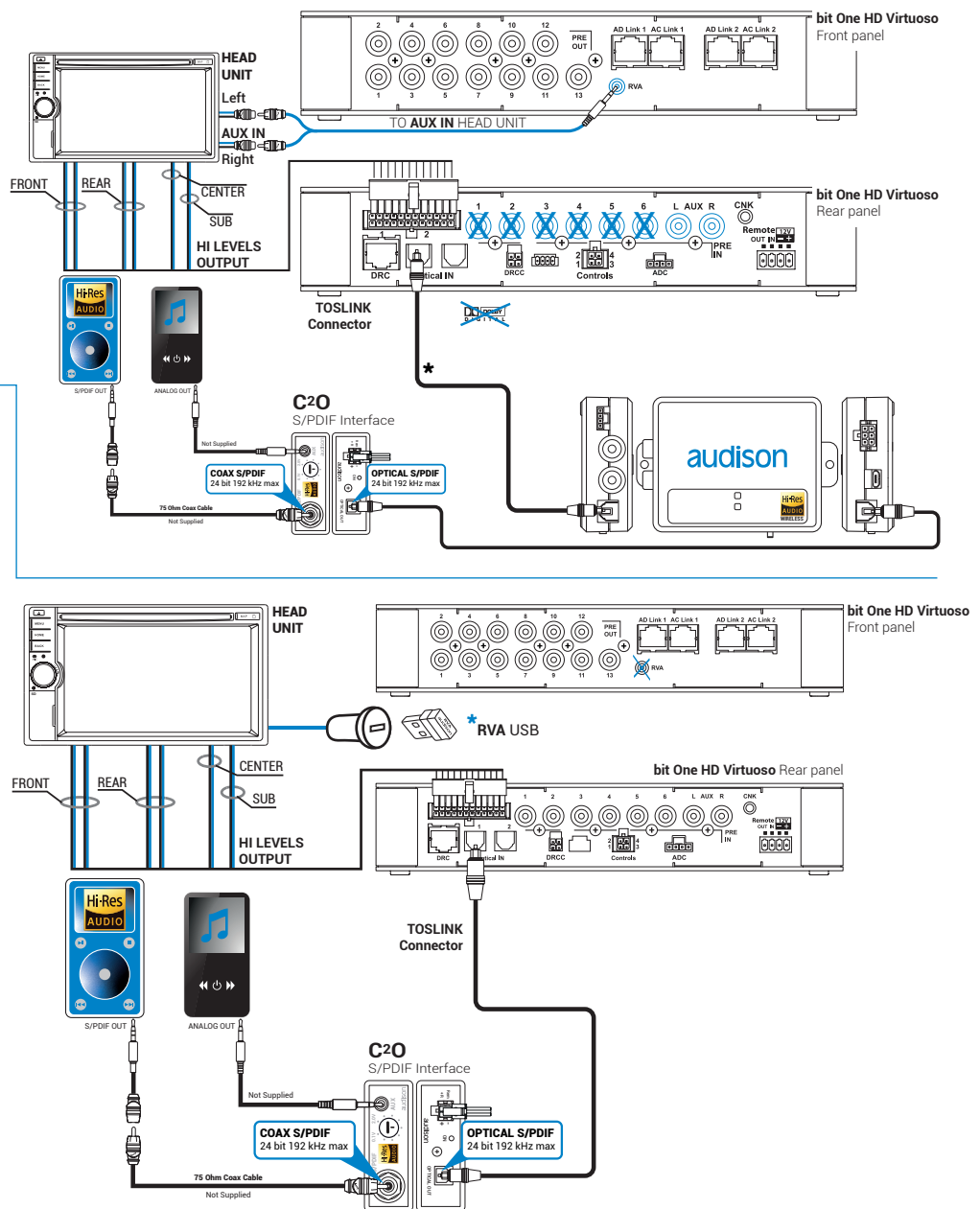

**5.7 OUTPUT SIGNALS**

**AD LINK-OUT**

**5.7.1. OUTPUT TO AN AMPLIFIERS SYSTEM PROVIDED WITH AD LINK AND AC LINK CONNECTION (THEESIS TH / AV AMPLIFIERS)**

(see section 7.2.2.12 - 7.2.3.9 - 7.2.4.5)

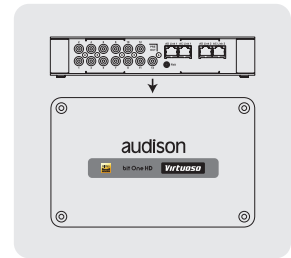

bit One HD Virtuoso  
 Top Side

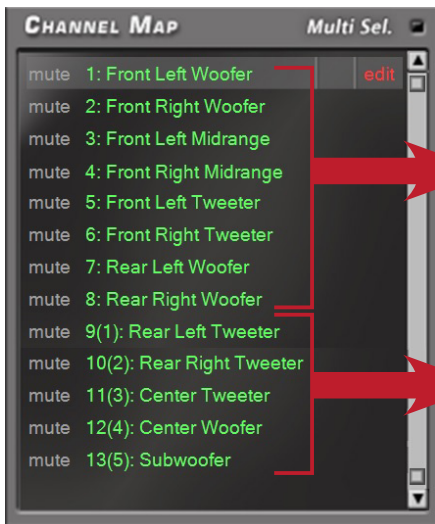
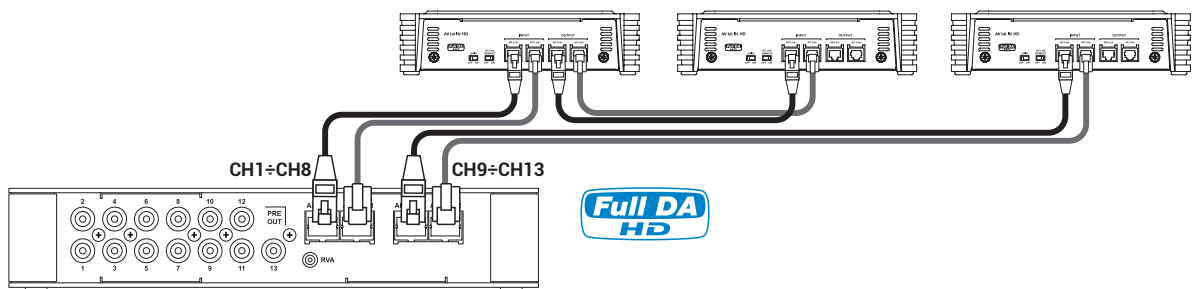

AD LINK 1

AD LINK 2

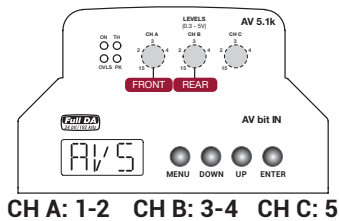
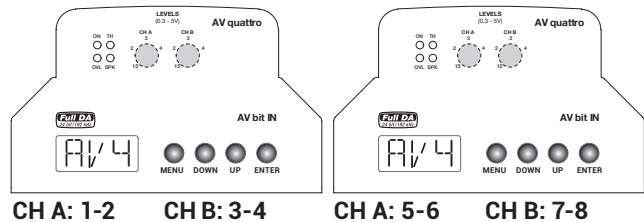

**Remark:** the output channels are 13 in total. The sum of the channels of the amplifiers connected must not exceed 13. To increase the number of channels, however, the same function (AMP ID) can be assigned to more than one amplifier.

**WARNING:** Output setups, with speakers named: Surround Left/Right, Front Super Tweeter Left/Right, Front Mid Bass Left/Right, Rear Midrange, are not compatible with AV bit In digital inputs. The same Setups are incompatible with AUTO SET systems performed with bit Tune.

**5.7.2. OUTPUT TO AN AMPLIFIERS SYSTEM WITH PRE INPUT**

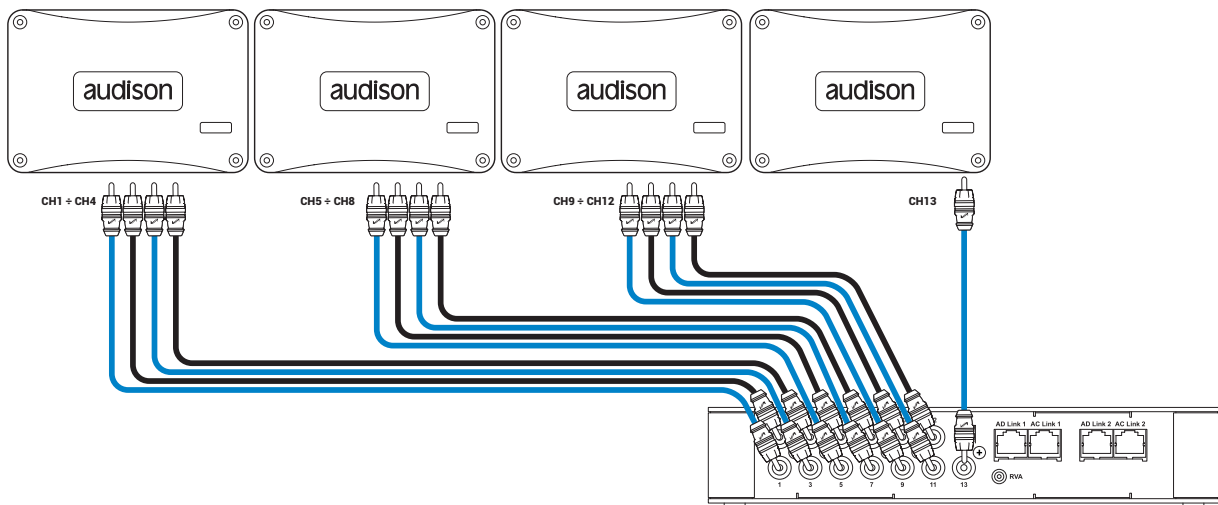

**5.7.3. OUTPUT TO AN AMPLIFIERS SYSTEM PROVIDED WITH AD LINK AND AC LINK CONNECTIONS (THIS IS TH) AND AMPLIFIERS PROVIDED WITH PRE INPUT** [\(see section 7.2.2.12 - 7.2.3.11 - 7.2.4.6 - 8.3.3\).](#)

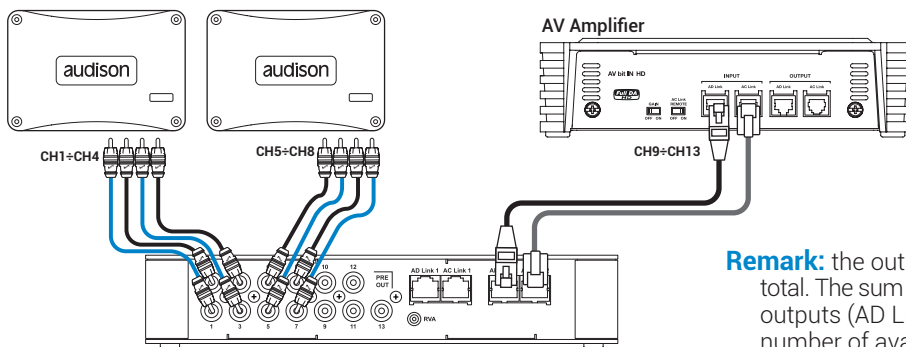

**Remark:** the output channels are 13 in total. The sum of the analog and digital outputs (AD Link) must not exceed the number of available channels.

## 6. bit One HD Virtuoso SOFTWARE AND DRIVERS - INSTALLATION GUIDE

Inside the USB Setup31 device, you can find all the files necessary for the setup of the bit One HD Virtuoso.

USB Setup31 contains:

- File setup folder. It contains the files for the PC Software installation.
- Auto-tuning audio files for Stereo systems:
  - MP3 320Kb/s format;
  - Wav PCM 44.1Khz 24 bit format.
- Auto-tuning audio files for 5.1 multimedia systems:
  - MP3 320Kb/s format.
- PDF format manuals for product/accessories.

### 6.1 SOFTWARE INSTALLATION GUIDE

1. Insert the USB "SETUP31" into the PC you are going to use
2. **Windows Vista:** select "**Computer**" from the Windows **START** menu;  
**Windows 7:** select "**Computer**" from the Windows **START** menu;  
**Windows 8/10:** click on the **DESKTOP** icon;

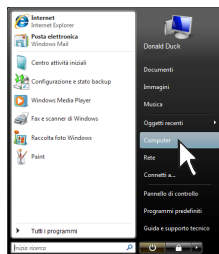

Windows Vista

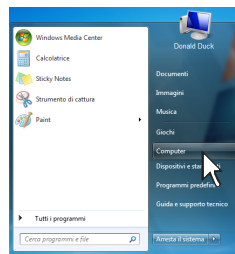

Windows 7

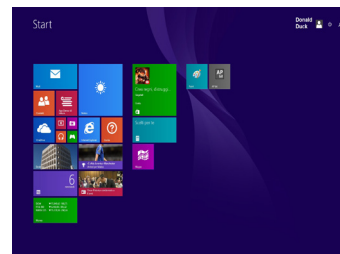

Windows 8/10

3. **Windows Vista:** right-click your mouse on the USB "SETUP31" icon and select "**Explore**";  
**Windows 7:** right-click your mouse on the USB "SETUP31" icon and select "**Open**";  
**Windows 8/10:** double click on the **Computer** icon.

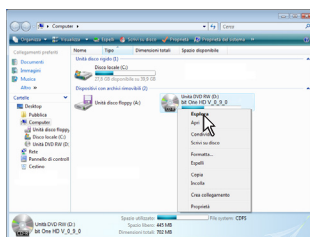

Windows Vista

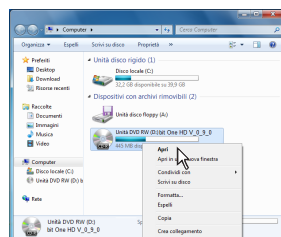

Windows 7

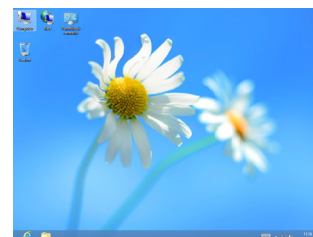

Windows 8/10

4. **Windows Vista:** double click on the "**setup**" icon;  
**Windows 7:** open the Setup folder and double click on the "**setup**" icon;  
**Windows 8/10:** select the USB drive and double click on **setup** icon.

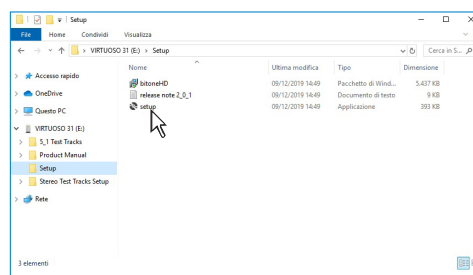

Windows Vista / Windows 7 / Windows 8/10

**Remark:** to remove any restrictions on Windows Vista 7/8/10 operating systems, right-click on the setup icon and select the option "Run as Administrator". Then select Yes to continue with the installation from the next window "User Account Control".

- 5. Windows Vista:** select **NEXT** to go on with the installation, **CANCEL** to interrupt it;  
**Windows 7:** select **NEXT** to go on with the installation, **CANCEL** to interrupt it;  
**Windows 8/10:** select **NEXT** to go on with the installation, **CANCEL** to interrupt it.

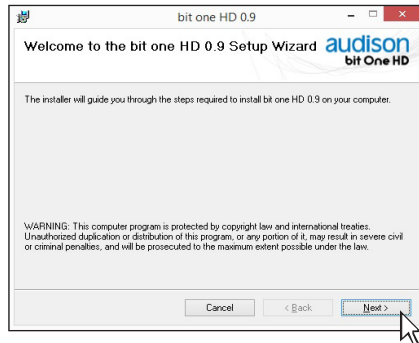

- 6. Windows Vista:** select **I Agree** and then **NEXT**;  
**Windows 7:** select **I Agree** and then **NEXT**;  
**Windows 8/10:** select **I Agree** and then **NEXT**;



- 7. Windows Vista:** select
- **Everyone** if you have the system administrator privileges, so, once installed, the program can be used by anyone who uses that PC;
  - **Just me** if you want that, once installed, the program can only be used by yourself as single system user. Then select **NEXT**;
- Windows 7:** select
- **Everyone** if you have the system administrator privileges, so, once installed, the program can be used by anyone who uses that PC;
  - **Just me** if you want that, once installed, the program can only be used by yourself as single system user. Then select **NEXT**;
- Windows 8:** select
- **Everyone** if you have the system administrator privileges, so, once installed, the program can be used by anyone who uses that PC;
  - **Just me** if you want that, once installed, the program can only be used by yourself as single system user. Then select **NEXT**;

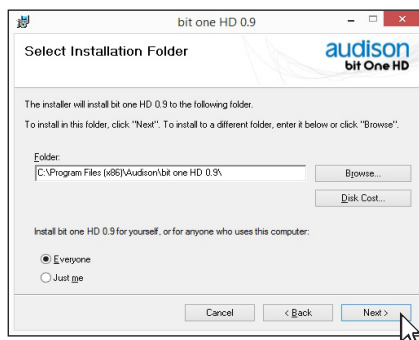

- 8. **Windows Vista:** go on and complete the installation procedure, then select **CLOSE** to exit the installation;
- Windows 7:** go on and complete the installation procedure, then select **CLOSE** to exit the installation;
- Windows 8/10:** go on and complete the installation procedure, then select **CLOSE** to exit the installation;



- 9. The bit One HD Virtuoso PC software is now installed in your system.

## 6.2 DRIVERS INSTALLATION GUIDE FOR WINDOWS VISTA, 7/8/10

1. Turn the bit One HD Virtuoso on.
2. Connect the USB cable located on the appropriate connector on the bit One HD Virtuoso to the USB available on the PC.

**WARNING:** when connecting a laptop PC via USB cable to the bit One HD Virtuoso while the device is turned on, the laptop has to work with its own battery, keeping it disconnected from the mains adapter (external power supply). Once the connection between the laptop PC and the bit One HD Virtuoso is established, you can immediately connect the computer, if necessary, through the mains adapter.

- 3. **Windows Vista:** the PC will recognize the bit One HD Virtuoso interface and will automatically install the driver;



Windows Vista

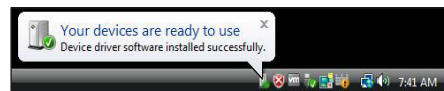

Windows Vista

- Windows 7/8/10:** the PC will recognize the bit One HD Virtuoso interface and will automatically install the driver;

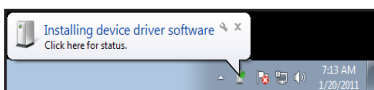

Windows 7/8/10

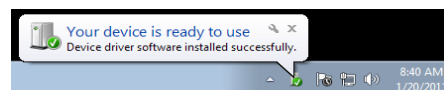

Windows 7/8/10

- 4. The peripheral device has been installed correctly and is ready for use.

**Remark:** the bit One HD Virtuoso uses HID drivers already integrated in Windows. For this reason, they are not included in the CD and will always install automatically.

## 6.3 bit One HD Virtuoso SOFTWARE UNINSTALL

To uninstall the bit One HD Virtuoso PC software you can use the link listed on the menu:

*Start / All Programs / bit One HD Virtuoso / uninstall*



## 7. bit One HD Virtuoso SETUP WITH PC

To adjust the bit One HD Virtuoso functions a software is required. The processor needs to be connected to the PC and turned on. After installing the software, start it by selecting the icon shown on your desktop.



The first window is the startup page where one of the following modes needs to be selected:

- **CONNECT WIRED USB**, connects the bit One HD Virtuoso to the PC via USB;
- **CONNECT WIRELESS WI-FI**, it allows the connection via **W-CON** module connected to the bit One HD Virtuoso in wireless mode with the PC;
- **OFF LINE MODE IIR FILTERS**, demo mode with active FIR Filters;
- **OFF LINE MODE IIR FILTERS**, demo mode with active IIR Filters;
- **RESCUE**, bit One HD Virtuoso connected for update/maintenance (see section 9.4).



### 7.1 OFFLINE MODE GRAFIC/PARAMETRIC IIR and PARAMETRIC FIR

In this case even if the bit One HD Virtuoso processor is connected to the PC, it does not interact with the software.

The **OFFLINE** mode can be used to work on the software to get familiar with the processor multiple functions without connecting the **bit One HD Virtuoso** to the PC and it is possible to select three operating modes: GRAFIC/PARAMETRIC IIR and PARAMETRIC FIR. For more information on the specific functions (see section 7.2) (**CONNECT** mode).

The software is pre-set to start with a 3-way Front active Stereo + 2-way Rear active Stereo + Sub + 2-way active central channel.

To set a new "virtual" system, and so to change the inputs and select the outputs, the function **I/O Configuration Wizard** in the "Config" window of the software main menu needs to be selected. Follow the same instructions as per **CONNECT** mode (see section 7.2).



Here is how the **bit One HD Virtuoso Grafic IIR** software appears when started in OFFLINE mode.

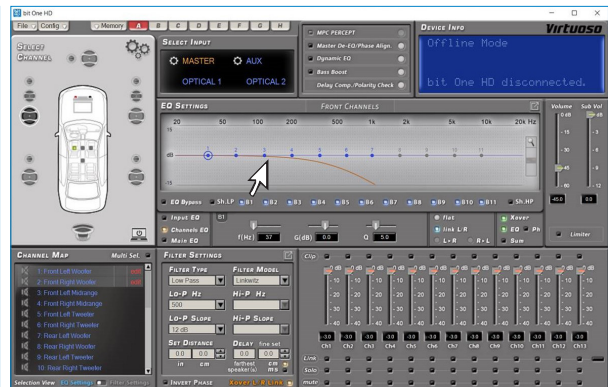

Here is how the **bit One HD Virtuoso Parametric IIR** software appears when started in OFFLINE mode.

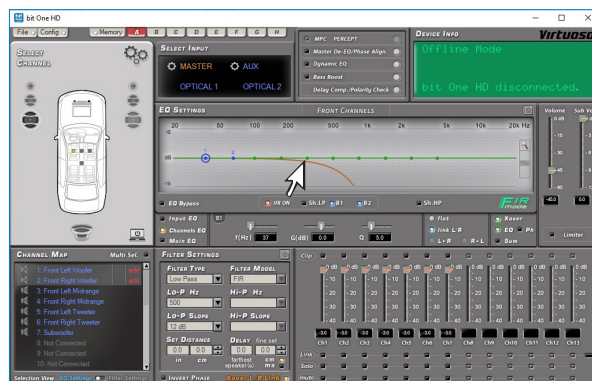

Here is how the **bit One HD Virtuoso FIR** software appears when started in OFFLINE mode.



**Pop Up Mode:**

- It is possible to exploit the active Pop Up mode during the setup of your audio system on the equalizer windows, Filter settings and Delay, to obtain greater resolution and have a better view of your setup. Clicking on the icon , the windows will be enlarged and it will be possible to make a more precise setup, to return to the main menu, just click outside the active pop up.

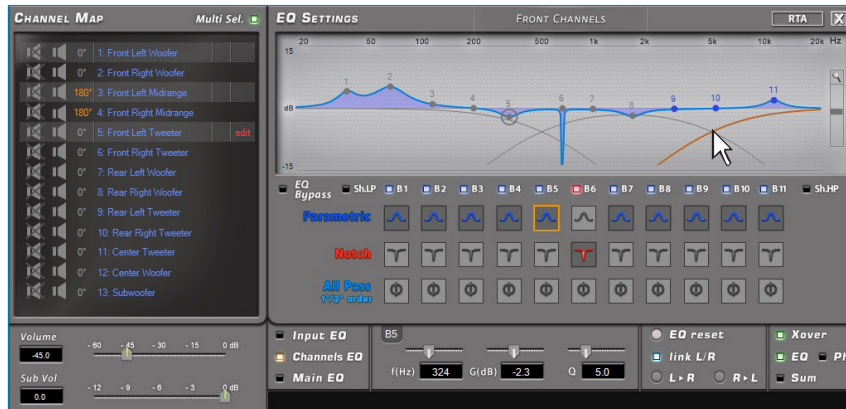

Pop-up Eq settings IIR Mode

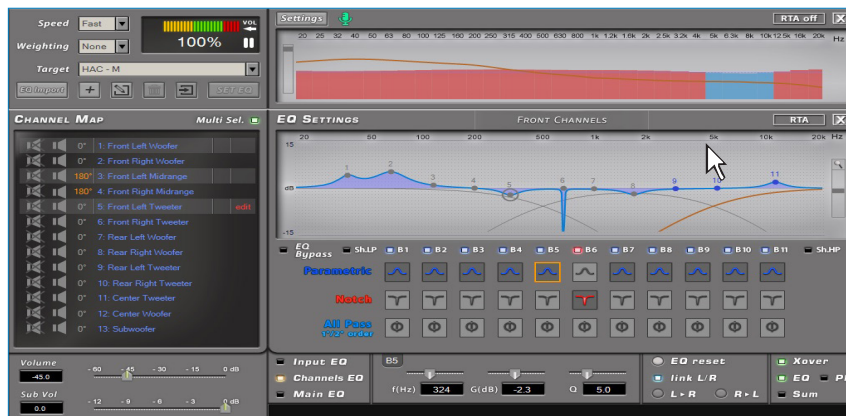

Pop-up Eq settings FIR Mode + RTA

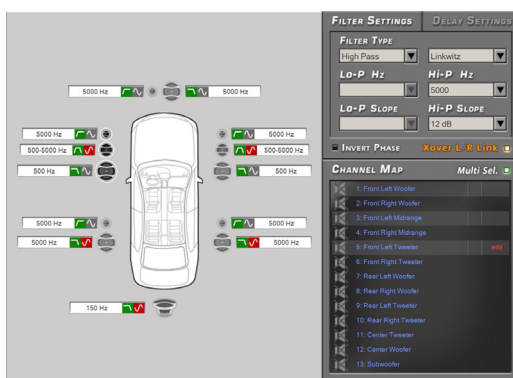

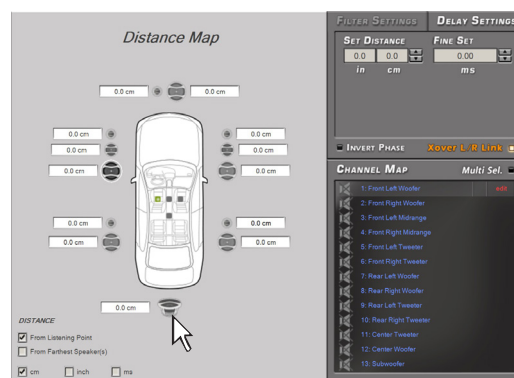

Pop-up Filter Settings



Pop-up Delay Settings

**How to change the size of the PC software window**

- To make the window full-screen, click on the Enlarge button  or double click on the title bar of the PC software window.
- To restore the previous size from full-screen, click  on the Reset button or double click on the title bar on the window.
- To resize the PC software window (make it smaller or larger), position the mouse pointer on one edge or corner of the window. When the mouse pointer becomes an arrow with a double point, drag the edge or corner to make the window larger or smaller

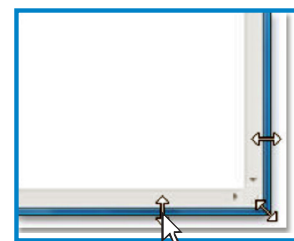

## 7.2 CONNECT MODE

In this case the bit One HD Virtuoso processor must be connected to the PC and turned on. The connection between PC and bit One HD Virtuoso can be established via USB or Wireless cable through the **W-CON** interface.

When switched on for the first time the product uses the filters on the IIR output channels by default, but it is then possible to select the FIR mode. Firmware 3.0 allows you to select these two operating modes using a single Firmware.

At this point it is necessary to know in advance the system that you intend to implement, since later, to modify these selections, you will have to run the guided procedure again.

Below is the check list to follow for the complete configuration of your bit One HD Virtuoso.

SETUP	OPERATION	REFERENCE
1	Connect the Master inputs of the bit One HD Virtuoso to the outputs of your audio system source. During this operation it is advisable to disconnect the RCA / AD LINK - AC LINK sockets of the bit One HD Virtuoso, connected to the amplifiers.	<a href="#">See sec. 5</a>
2	Connect the bit One HD Virtuoso to the PC, switch on the audio system.	<a href="#">See sec. 6 - 7</a>
3	Open the bit One HD Virtuoso Pc software previously installed in the PC.	<a href="#">See sec. 7.2</a>
4	Start the config "I/O CONFIGURATION WIZARD".	<a href="#">See sec. 7.2.1</a>
5	Set the filters of all the bit One HD Virtuoso output channels according to the characteristics of your speakers.	<a href="#">See sec. 8.7.1</a>
6	Set the bit One HD Virtuoso time delays manually.	<a href="#">See sec. 8.7.2</a>
7	Finalize the bit One HD Virtuoso. Exit the PC Software and turn off the system. Reconnect the Bit One HD outputs to the amplifiers, and restart the system and PC software.	<a href="#">See sec. 8.2.3</a>
8	Select through the "solo" function all the speakers that make up the FRONT Left, and adjust the output levels, the polarity. Perform this operation for the FRONT Right, REAR Left, REAR Right. Enable via the "solo" function only the SUBWOOFER channel(s), together with the previously adjusted fronts and perform its level calibration, phase. To perform a calibration of the output levels it is advisable to perform an RTA of the system via bit Tune. ( <a href="#">see sec.8.8.4</a> )	<a href="#">See sec. 9.3.5 - 11.2</a>
9	Select Input eq and optimize the input equalization curve and the possible presence of ALL PASS. If the DE-EQ / Phase Adjustment has been carried out, it will be possible to intervene on the results and further refine them.	<a href="#">See sec. 8.8.1 - 8.12.2 - 11.2</a>
10	Select all the speakers of the FRONT and through an RTA and PINK NOISE, set the output channels levels, Polarity and CHANNELS EQ equalization. ( <a href="#">see sec.8.8.4</a> )	<a href="#">See sec. 8.9.5 - 8.8.2 - 11.2</a>
11	Select all the speakers of the REAR and through an RTA and PINK NOISE, set the levels of the output channels, Polarity and equalization CHANNELS EQ.	<a href="#">See sec. 8.9.5 - 8.8.2 - 11.2</a>
12	Make the whole system play and through an RTA and PINK NOISE, set the levels of the output channels, Polarity and equalization.	<a href="#">See sec. 8.8.2 - 8.9 - 11.2</a>
13	Select MAIN EQ and set the desired frequency response, depending on the preferred acoustic approach.	<a href="#">See sec. 8.8.3</a>
14	Use the BASS BOOST function to set the low frequency response.	<a href="#">See sec. 8.12.4</a>
15	By listening to your favorite music, you can further refine your system by intervening at points 9 ÷ 13.	
16	*Copy the current memory to the other memories to create starting bases for other setups, or select a new memory and repeat points 10 ÷ 15.	<a href="#">See sec. 8.4</a>
17	FINALIZE THE BIT ONE HD	<a href="#">See sec. 8.2.3</a>

**\*Remark:** in the case of the Pass through, only one memory linked to the Master input will be available and it will not be possible to copy this memory to the other remaining and vice versa. The other available memories will be available for the other AUX, Optical 1/2 inputs available.

**PC software turn on in CONNECT MODE:**

Upon turn on, if correctly interfaced with the PC (software and drivers installed correctly), the device will show the communication window as shown in the figures to the side.



If at the end of the scanning the bit One HD Virtuoso is not found:

- check that the bit One HD Virtuoso is switched on (Audison logo light on);
- check that the USB cable is connected correctly;
- press **OK** to search for the device again;
- press **CANCEL** to start the OFFLINE mode.



In the default configuration, the bit One HD Virtuoso is configured as shown below:

Input Hi Level Master:

- CH1 Front Left Full
- CH2 Front Right Full
- CH3 Rear Left Full
- CH4 Rear Right Full

**AUTO TURN ON Hi Level:** enabled

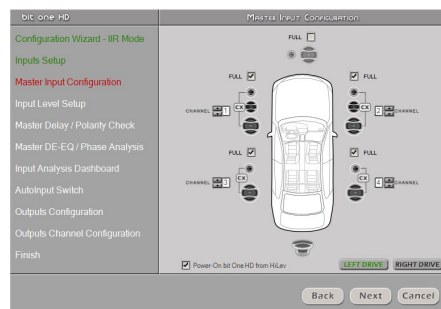

**Output Analog (Pre Out):**

- CH1: Front Left Woofer - CH2: Front Right Woofer
- CH3: Front Left Midrange - CH4: Front Right Midrange
- CH5: Front Left Tweeter - CH6: Front Right Tweeter
- CH7: Rear Left Woofer - CH8: Rear Right Woofer.
- CH9: Rear Left Tweeter - CH10: Rear Right Tweeter
- CH11: Center Tweeter - CH12: Center Woofer
- CH13: Subwoofer

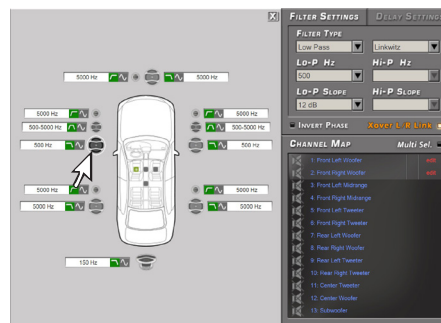

### 7.2.1 I/O CONFIGURATION WIZARD

At this point it is necessary to know in advance the system that you intend to create, since later, to modify these selections, you will have to run a guided procedure.

More specifically the guided procedure will request:

- Which type of output filter to use: FIR or IIR. Remark: in the FIR mode you can have a maximum of 9 output channels.
- Whether to choose between an output system with reconstruction of the input front or PASS THROUGH.
- Whether or not to perform a complete analysis of your OEM audio system, in order to maximize the results.
- Which types of main entrances will be used, whether at high level or low level. This choice will not prevent the use of low-level or digital auxiliary sources. The guided procedure changes according to the selection.
- If you intend to turn on the product via "HI LEVEL TURN ON" (ART).
- Which auxiliary inputs will be used (i.e.: AUX o OPTICAL IN ... etc.).
- What kind of signals will be assigned to the main inputs (i.e.: Front Left or Center or Subwoofer etc.).
- Which speakers make up the system (i.e.: 3-way Front or Sub stereo or 2-way Rear etc.).
- If there are passive crossovers that manage groups of speakers (i.e.: 3-way system with active medium-low).
- If there are amplifiers connected via the AC Link.
- If your source is able to play audio files in Wav format, use the Test tracks contained in the Wav test Tracks Setup folder. If your source cannot play Wav files, use the MP3 format Test tracks contained in the MP3 test Tracks Setup folder. If your source is multimedia and capable of playing 5.1 files, use the MP3 format Test tracks contained in the 5\_1 Test Tracks folder.

**Remark:** The MP3 test tracks provided are converted to the highest possible resolution.

**WARNING:** during this operation it is advisable to disconnect the **RCA / AD LINK - AC LINK** sockets of the bit One HD Virtuoso, connected to the amplifiers.



Click on the **Config** menu and select **I/O Configuration Wizard**.

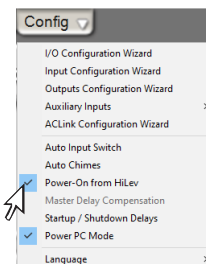

#### Configuration wizard for the system to be implemented

Select the operating mode between Graphic/Parametric IIR or Parametric FIR.

- Choose Automatic Routing for the reconstruction of the automatic fronts ([see sec. 7.2.2](#)).
- Select Pass through ([see sec 7.2.3](#)) if you intend to interface with complex OEM audio systems, featuring surround systems, and audio customization algorithms.

This mode will allow you to maintain the main performance of your OEM system, interfacing it 1 to 1 or extended.

This mode will also allow the OEM source to be released with respect to the available auxiliary inputs (Optical / AUX), creating a new system that is completely independent from the OEM one, being able to customise the other sources available in a more complex way.

**Remark:** when selecting the PASS THROUGH mode, set the memory relating to the OEM master input.

Press **NEXT** to continue with the configuration.

Press **CANCEL** to exit.

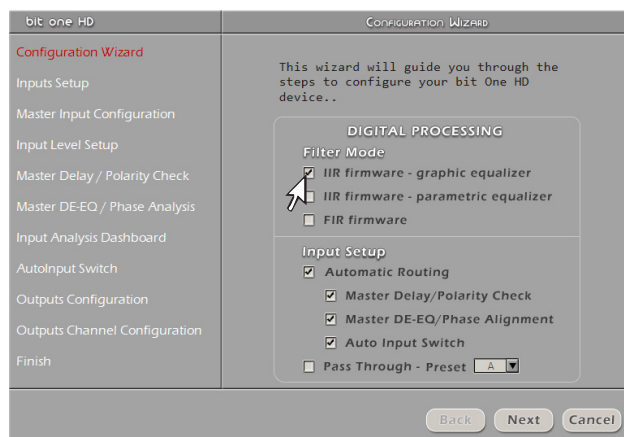

7.2.2 AUTOMATIC ROUTING

automatic routing

The choice of I/O configuration using the "Automatic Routing" provides the ability to interface with your source outputs automatically, allowing you to specialize the inputs and the outputs after analysing them. The procedure can be performed completely in the following way:

- a. Master Delay / Polarity Check.  
It allows to identify and compensate for possible time delays and electric phase inversion of the OEM source interfaced with the bit One HD Virtuoso;
- b. Master DE-EQ / Phase Alignment. It allows the user to carry out an analysis of the emission fronts, in this case the Equalization curve is identified, any All Pass present, compensating them if necessary. Furthermore, an analysis is made of the progress of the channels that make up the front in order to manually compensate for any crossover points.
- c. Auto Input Switch. It enables the activation of the automatic control of the auxiliary source (Aux - Optical 1/2) by controlling the volume of your vehicle's audio source ([see sec. 5.4.3 - 5.6.1](#))

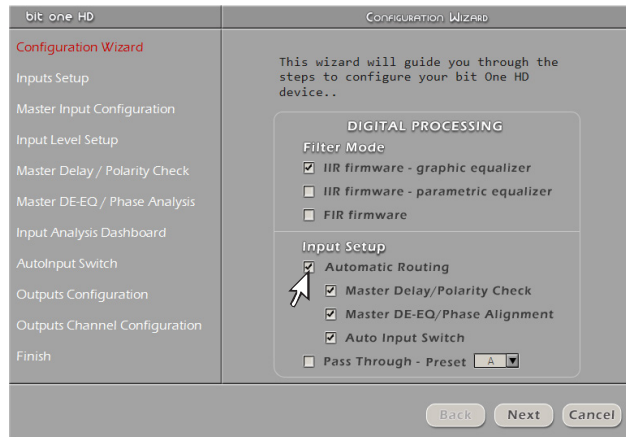

The software allows the user to select all three points or just the ones needed to get the best performance from the audio setup.

1. Inputs selection

- Select the main inputs (MASTER) type (High Level, Low Level, or Optical 1) used. If you select the Master Optical 1 input go to point 8, otherwise continue to point 2. To change this setting at a later stage, the **I/O Configuration Wizard** guided procedure will have to be performed again
- Select among the available auxiliary inputs, AUX - OPTICAL 1 - OPTICAL 2, the ones which will be used. The setting can be changed at a later stage by selecting "Config / External Source" on the software main menu.

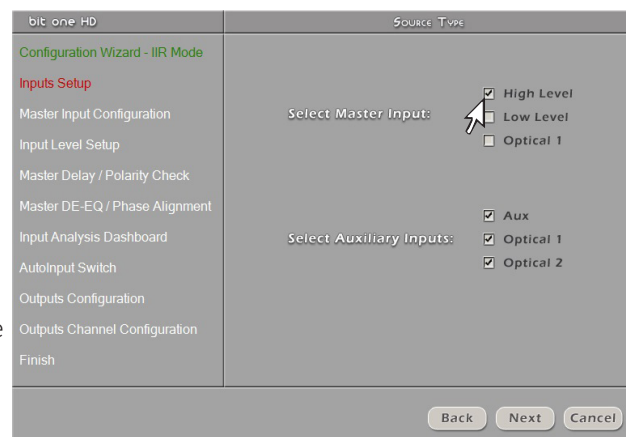

Press **BACK** to go back to the previous step.  
Press **NEXT** to continue with the configuration.  
Press **CANCEL** to exit.

## 2. Analog inputs configuration

The inputs can be selected by clicking on the system's loudspeakers assigning the corresponding channel number. Based on the type of analog input there will be:

- **Low Level** the following input channels are available: Front Left Full, Front Right Full, Rear Left Full, Rear Right Full, Center Full, Subwoofer.

In order to fully optimize the audio system, connect all audio outputs of the source to the bit One HD inputs, thus obtaining a correct sound reproduction.

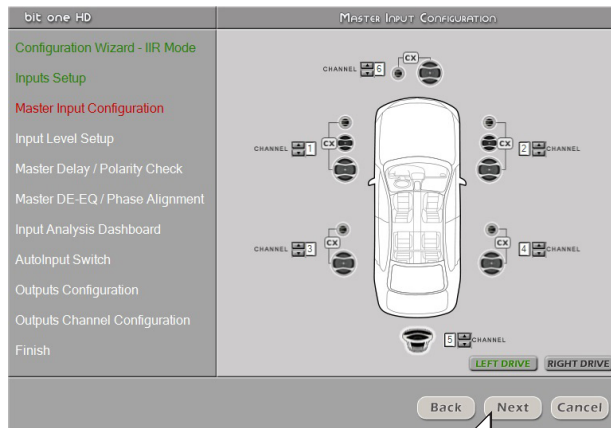

Low Level inputs

- **High Level** 12 input channels are available and can be manually assigned.

In order to fully optimize the audio system, connect all audio outputs of the source to the bit One HD inputs, thus obtaining a correct sound reproduction.

**Remark:** in this phase of the setup it is possible to graphically define the driving side of the car Left (default) or Right.

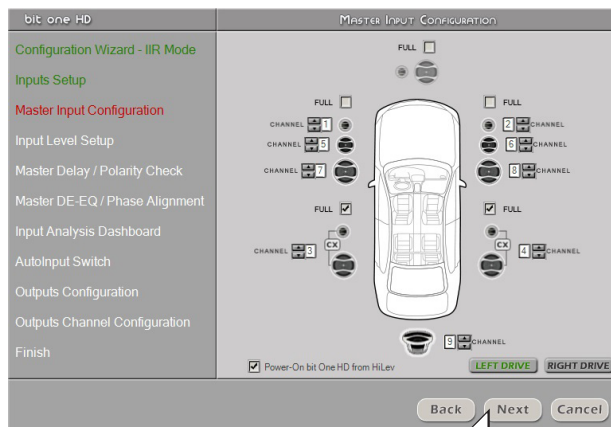

High Level inputs

Press **BACK** to go back to the previous step.  
 Press **NEXT** to continue with the configuration.  
 Press **CANCEL** to exit.

### 3. Analog MASTER inputs levels calibration

Calibration is absolutely required to adapt the bit One HD Virtuoso inputs sensitivity to the signal coming from the source.

- Press **BACK** to go back to the previous step.
- Press **NEXT** to continue with the inputs calibration.
- Press **SKIP** to bypass the inputs calibration procedure

Follow the instructions listed below:

- Insert the supplied CD

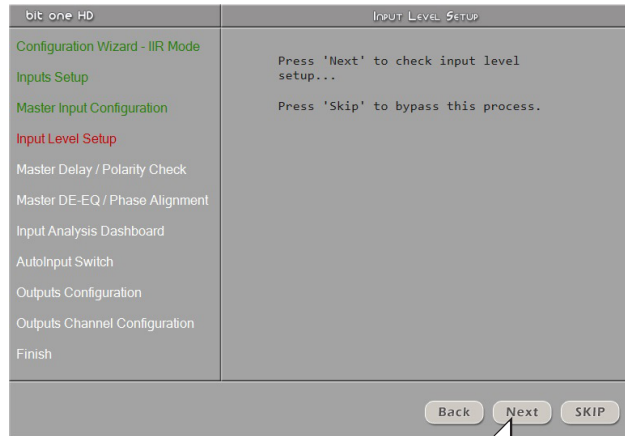

- Select the type of Test tracks contained in the USB device "SETUP31" (supplied with the product) according to your source (Head Unit), as shown below.
- "Wav Test Tracks Setup" folder if your source can play Wav format files.
- "MP3 Test Tracks Setup" folder if your source can not play Wav format files but only MP3.
- "5\_1 Test Tracks" Folder if your source can play 5.1 multimedia files.

**Remark:** the different types of tracks are available and downloadable from the Audison website ([www.audison.eu](http://www.audison.eu)), in the download section of the product bit One HD Virtuoso.

- Play track 1 (press Play);
- Set all tone controls to zero (0);
- Set balance and fader to center (0);

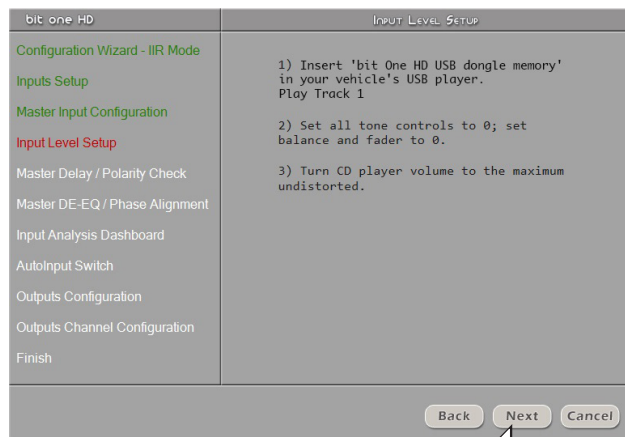

Press **BACK** to go back to the previous step.  
 Press **NEXT** to continue with the configuration.  
 Press **CANCEL** to exit.

**Remark:** the calibration is essential to adapt the bit One HD Virtuoso sensitivity to the signal coming from the source.

**Important Remark:** the head unit level must be elevated to the maximum undistorted level. If the head-unit level can not be tested in advance, bring the volume adjustment to approximately 80% of its maximum excursion. If the head-unit output level is set at a lower level the bit One HD Virtuoso will produce a ground noise (hissing sound). Should such noise come from the bit One HD Virtuoso during reproduction, the calibration procedure will need to be repeated at higher volume.

#### 4. Input level automatic calibration

A progress bar and specific messages show the procedure's implementation.

Once the procedure is completed, the window will show the message "Press Next to Continue".

- Press **BACK** to go back to the previous step.
- Press **NEXT** to continue with the configuration.
- Press **CANCEL** to exit.

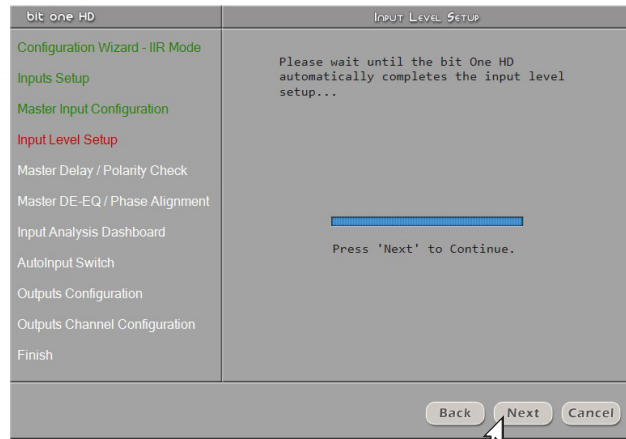

Once the procedure is completed the window will show the sensitivity levels setup according to the source interfaced with the bit One HD Virtuoso. This window is active and a further manual sensitivity adjustment can be performed.

#### Select:

- Ref: 0dB Reference setup referring to the use of music tracks recorded at 0dB
- +3dB - +6dB: referring to the Use of music tracks recorded at a level **lower than 0dB (-3dB ÷ -6dB)**
- Press **BACK** to go back to the previous step.
- Press **NEXT** to continue with the configuration.
- Press **CANCEL** to exit.

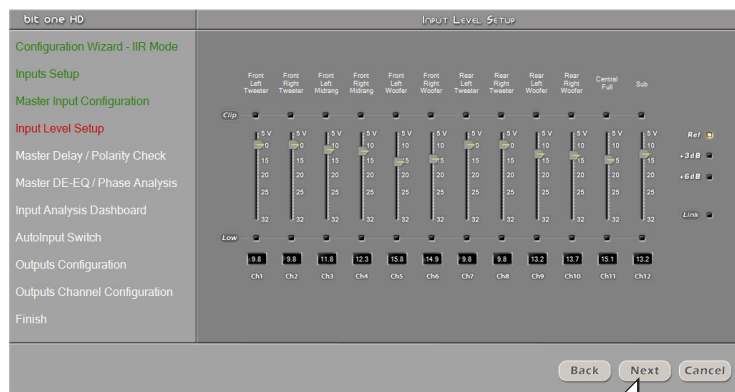

#### ERROR MESSAGE MAY APPEAR

##### "Input Level too low"

Should a message informing the user that the input signal is too low "Input too low" appear when the inputs calibration is completed, proceed as follows:

- Press **BACK** to go back to the previous step, check the inputs connection to the bit One HD Virtuoso and repeat the calibration procedure
- Press **NEXT** to continue with the configuration, check the inputs connection. And then proceed with the manual sensitivity calibration ([see section 8.11](#)).
- Press **CANCEL** to exit.

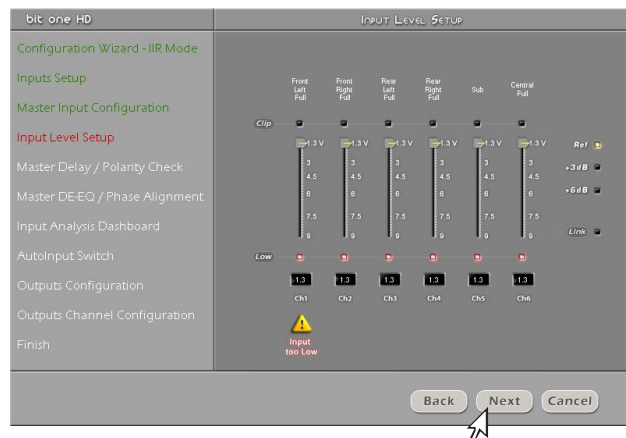

## 5. Master Input Delay / Master Input Polarity

The presence of time delays on the inputs of the Head Unit interfaced to the bit One HD Virtuoso as well as any phase inversions of the signal used can be verified.

- Press **BACK** to go back to the previous step.
- Press **NEXT** to continue with the configuration.
- Press **CANCEL** to exit.

Follow the instructions listed below:

- Iset all tone controls to zero (0);
- set balance and fader to center (0);
- do not change the volume level previously set through the inputs level automatic calibration;
- play track 3 (press Play);

- Press **BACK** to go back to the previous step.
- Press **NEXT** to continue with the configuration.
- Press **CANCEL** to exit.

A progress bar and specific messages show the procedure's implementation. Once the analysis is completed, the window will show the results referred to time delays in the audio source, and the possible phase inversion connection of the applied audio signal.

### A) Master Delay compensation:

- **is not necessary:** the source has no time delays set;
- **is necessary:** the source has time delays set. By selecting Enable the output time delays will be compensated.

### B) Speaker IN Polarity Check Result:

- The presence of green checks next to the loudspeakers indicates that the electrical connection of the inputs with respect to the source outputs has been performed correctly.
- The presence of red checks next to the loudspeakers indicates that the connection of an input or multiple inputs was made by inverting the cables.

You can proceed as follows:

- Select "Automatic Polarity Correction", the software will invert the phase to all the speakers displayed in red.
- Select "Manual electric Polarity Correction", the software will only inverse the channels selected in red and inverted manually.

- Press **BACK** to go back to the previous step.
- Press **NEXT** to continue with the configuration.
- Press **CANCEL** to exit.

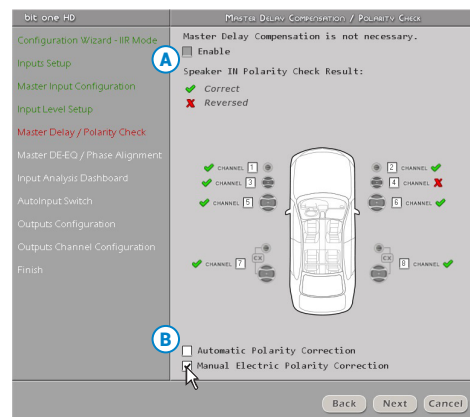
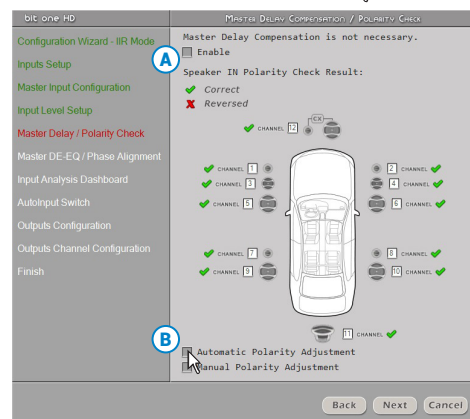
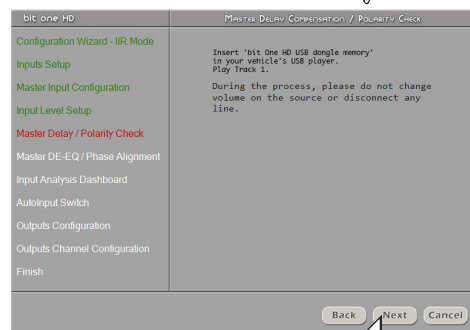
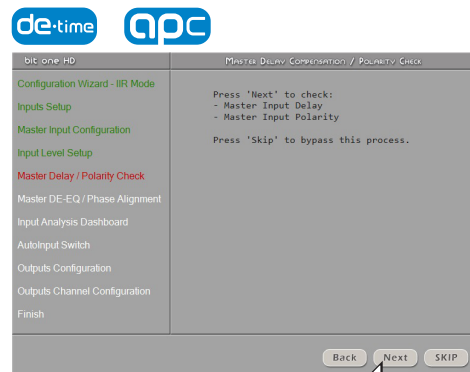

## 6. Source De-equalization / Phase Analysis

Operation not mandatory, but necessary for equalized OEM sources. The de-equalization process performs an analysis of the electrical frequency response coming from the different channels of the OEM source, automatically applying an equalization contrary to the original one, thus generating a linear signal, much more suitable to drive high quality audio systems. Regardless of the input channels used, the de-equalization will be performed for each functional group.

**E.g.:** even though Front Left Full and Front Right Full inputs are used, the software will perform the de-equalization also on Rear, Center and Subwoofer inputs as the processor will have to use the signals identified as Front to possibly also manage the Rear, Center and Subwoofer outputs.

Press **BACK** to go back to the previous step.

Press **NEXT** to continue with the configuration.

Press **SKIP** to bypass the de-equalization procedure.

### - De-equalization procedure fase

In addition to analysing the equalization curve of the OEM source, the procedure is able to identify and compensate for any All-Pass filters present on the emission fronts.

If you decide to carry out this complete procedure put the check mark on "Phase Analysis" and follow the instructions below:

- Iset all tone controls to zero (0);
- set balance and fader to center (0);
- do not change the volume level previously set through the inputs level automatic calibration;
- play track 2 (press Play);

- Press **BACK** to go back to the previous step.

- Press **NEXT** to continue with the configuration.

- Press **CANCEL** to exit.

### POSSIBLE ANALYSIS MESSAGE

If the software identifies the presence of recursive algorithms in the OEM source, it recommends the user to switch to the PASS-THROUGH mode.

- Press **BACK** to go back to the previous step.

- Press **NEXT** to continue with the configuration.

- Press **CANCEL** to exit.

- Press **PASS-THROUGH** to switch to this mode.

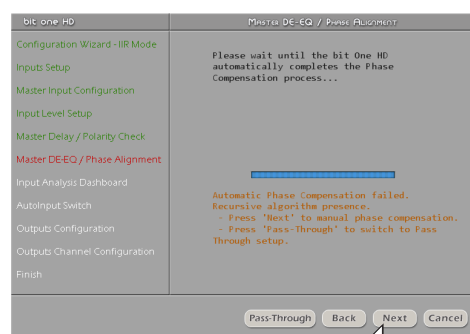
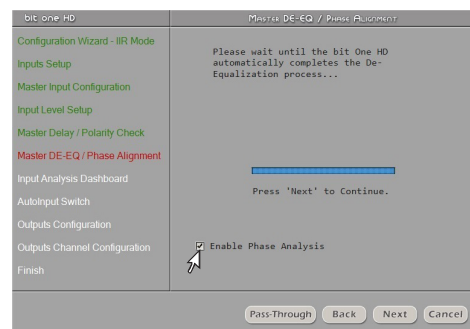
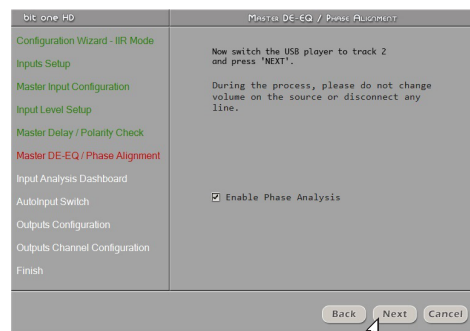

### 7. INPUT Analysis Dashboard.

At the end of the procedure the results of the analysis of the fronts of the interfaced source will be shown. By selecting Module the frequency trend of the signal will be displayed (Master EQ), the curve calculated to compensate for the present equalization (Master De-Eq), the trend of the sum (SUM), in addition the software will calculate the trend of any input filters (XOVER) available. Clicking on each individual chart on the front, it will be possible to enlarge the trend of each individual front. It is also possible to display in this window the presence of time delays on the source if analysed, if any.

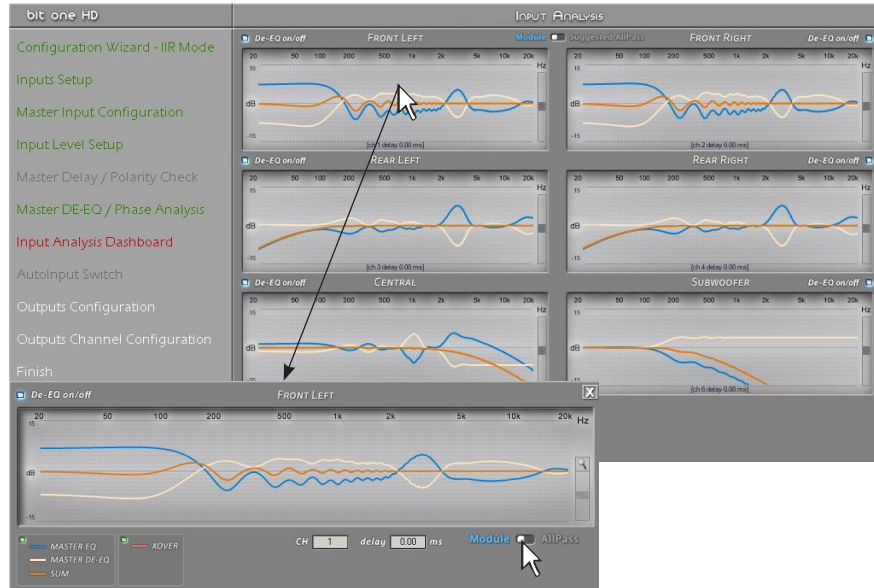

By selecting Suggested All Pass, instead, the phase compensation of the fronts suggested by the software will be displayed. It is applied via All-Pass first and second order filters according to the OEM source algorithm. In addition the software will display the electric response provided by the fronts selection, to inform the user about the suggested compensation. It will be possible after the end of the "I / O Configuration Wizard" to optimize the positioning of these filters or enable them ([see sect. 8.8.1](#))

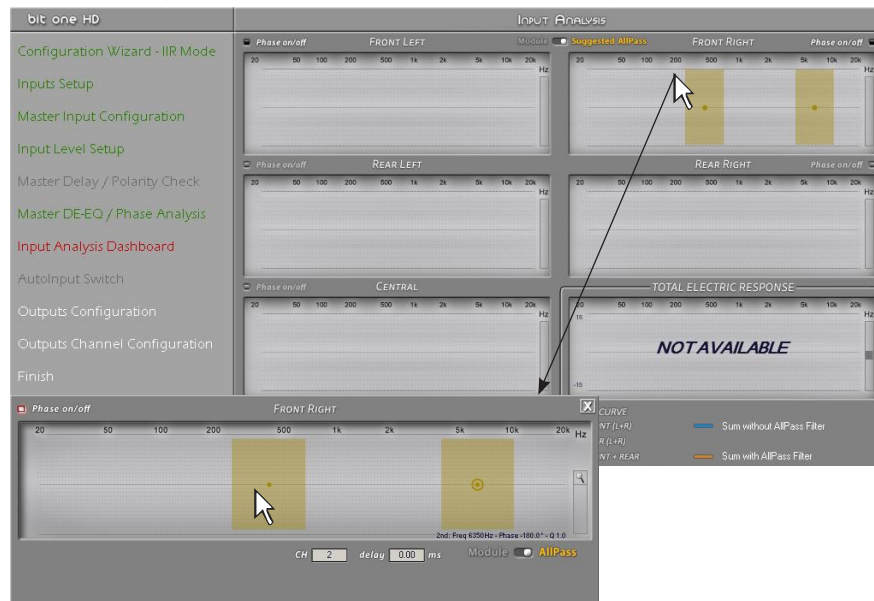

- Press **BACK** to go back to the previous step.
- Press **NEXT** to continue with the configuration.
- Press **CANCEL** to exit.

## 8. Auto Input Switch

The automatic volume control for the auxiliary source (Aux - Optical 1/2) can be activated through the Head Unit volume control, if it is provided with an AUX input ([see sec. 5.4.3, 5.6.1, 8.3.5](#)).

If the car HEAD UNIT does not have an AUX analog input, connect a USB memory (or SD Card) to the USB reader of your audio source as shown to the side. The USB/SD device must contain the mp3 format file available in the RVA TONE folder located inside the Setup CD (these files can also be downloaded from the Audison website).

Please note that the storage device must only contain this file and no other files. If you use the USB memory to activate

the switching via the RVA function, simply select the USB (SD) or Master input.

- Press **BACK** to go back to the previous step.
- Press **NEXT** to continue with the configuration.
- Press **SKIP** to bypass the procedure.

Follow the instructions listed below:

- 1) Use of the Head Unit AUX input:
  - connect the Head Unit AUX IN inputs to the RVA connector of the bit One HD Virtuoso using the appropriate cable.
  - select the source AUX IN input (Head Unit).
  - set the source volume to the maximum undistorted level.
- 2) Use of the Head Unit USB input:
  - Press NEXT and then adjust the RVA function settings as per [section 8.3.5](#).

At the end of the procedure:

- Press **BACK** to go back to the previous step.
- Press **NEXT** to go ahead with the configuration.
- Press **CANCEL** to exit.

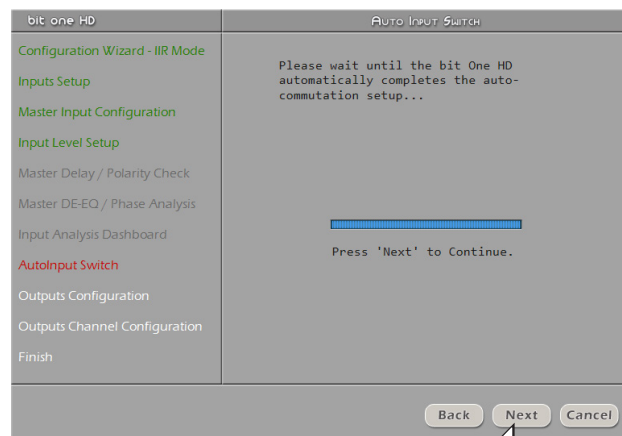
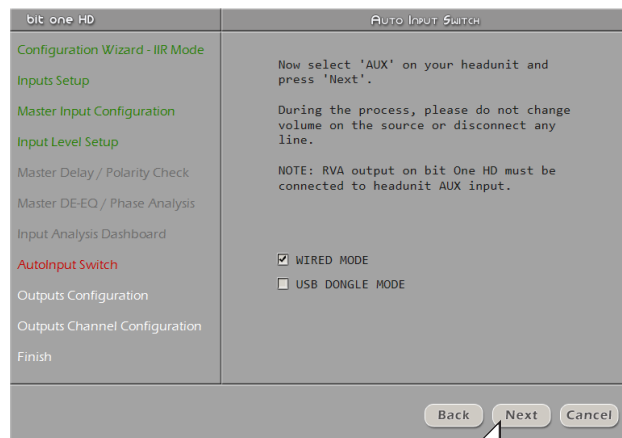
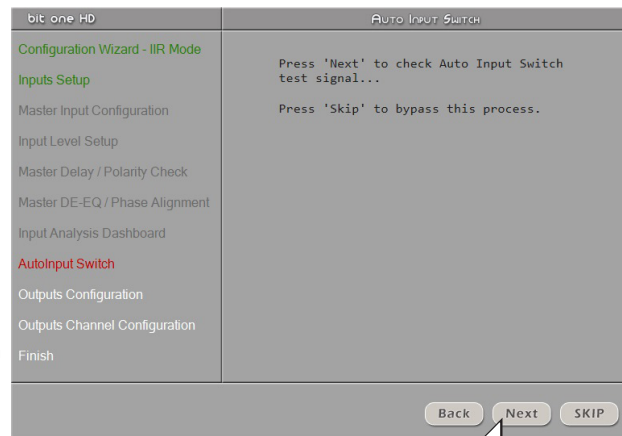

### 9. Selection of the speakers available in the system

Speakers can be selected just by clicking on them. If the left tweeter, left midrange or left woofer are selected, the software provides the ability to automatically activate also the right tweeter, right midrange or right woofer. Once the software is started, this choice will affect the dedicated crossover type

**E.g.:** if on the rear system only the woofers are activated, the software will only show a low-pass or band-pass filter as available. If you want to use a coaxial system as rear channel, both tweeter and woofer need to be selected and then you need to specify that a passive crossover is connecting them, so the software will show a high-pass filter as available.

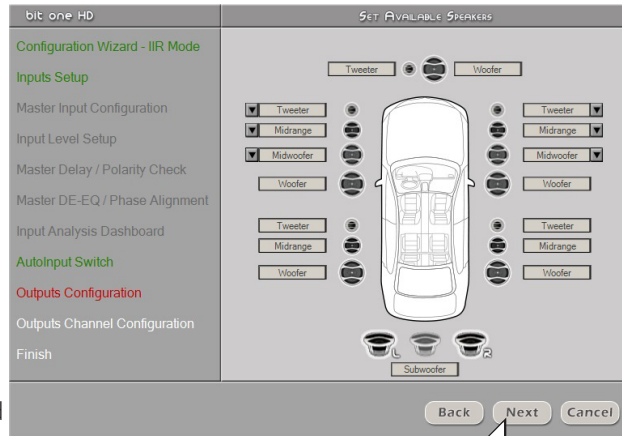

**Remark:** if you decided to use the FIR mode the bit One HD Virtuoso will avail of a maximum of 9 output channels to be enabled.

- Press **BACK** to go back to the previous step.
- Press **NEXT** to go ahead with the configuration.
- Press **CANCEL** to exit.

From this point onwards a simulation of a system with the following components will be used:

- 3-way Front active
- 2-way Rear active8
- 2-way center passive
- Stereo Sub;

All 13 output channels of the **bit One HD Virtuoso** in IIR mode will be used.

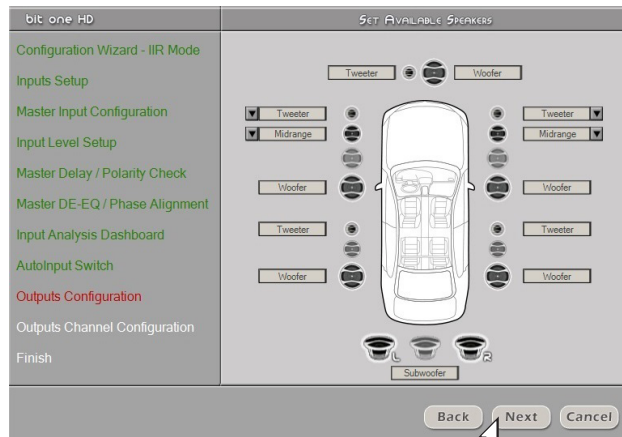

**Remark:** Audio systems with at least 4-way front or 3 Rear are not fully compatible with AV bit In and bit Tune.

### 10. Selection of passive crossovers for speaker groups

The presence of passive crossovers managing speaker functional groups in complex systems can be provided by the user.

**E.g.:** the 3-way Front can be managed as

- multi-amplified (6 output channels would be required);
- passive mid-high speakers + separately amplified woofer (4 output channels would be required);
- 3-way passive (2 output channels would be required).

While performing the setup, the software will automatically notify the return within the 8 output channel limit, the warning message will then disappear and the **NEXT** button will appear.

- Press **BACK** to go back to the previous step.
- Press **NEXT** to continue the configuration.
- Press **CANCEL** to exit.

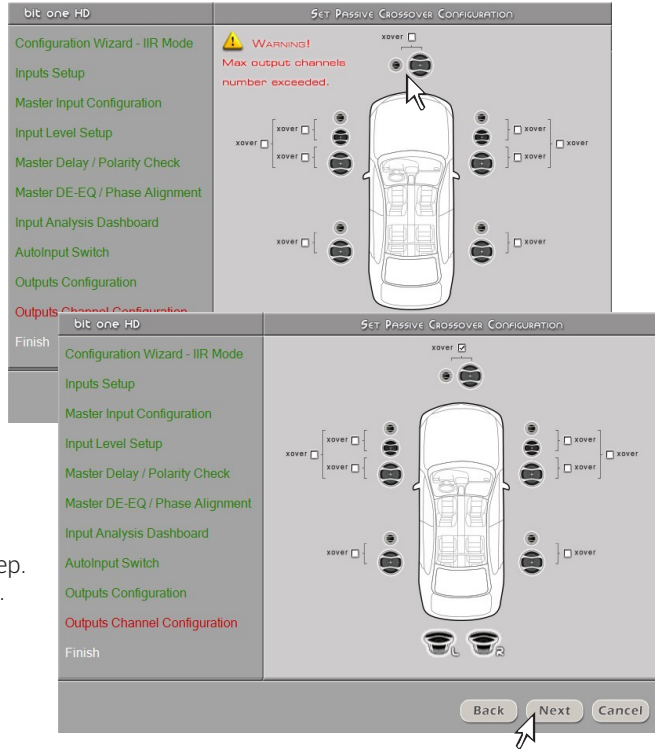

### 11. Processor outputs (Ch1÷Ch13 IIR MODE) assignment.

The bit One HD Virtuoso features 13 output channels. On this specific step of the procedure, any signal can be assigned to each output channel.

**E.g.:** the outputs 1 and 2 can be assigned to the rear channels simply to avoid having to lengthen the cables going to the specific amplifier.

For a matter of convenience, if the output 1 is assigned to the left woofers, the software will automatically assign the output 2 to the right woofers. If during the procedure the output 1 is assigned also to the left mid-high speakers, the software will show a warning message. Change the allocation of one of the two numbers marked in red and the software will automatically select the first available channel.

- Press **BACK** to go back to the previous step.
- Press **NEXT** to continue with the configuration.
- Press **CANCEL** to exit.

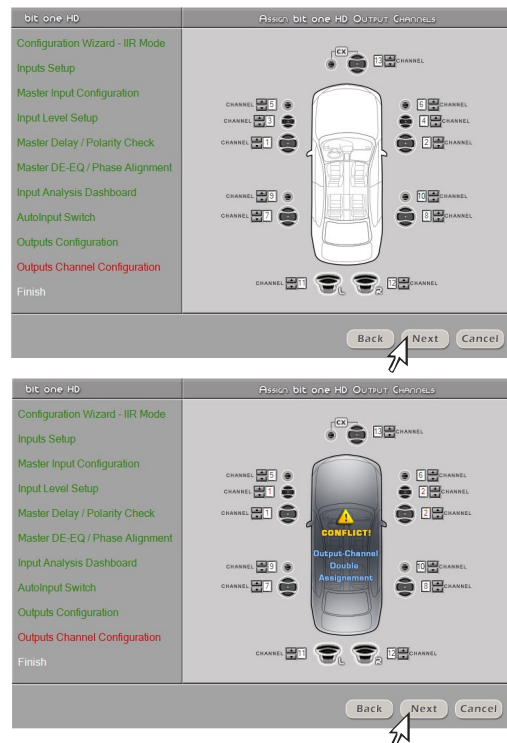

### 12. Selection of the amplifiers connected through the AD Link / AC Link connection system

If the system features amplifiers provided with the AD Link digital input and you want to connect them to the system, you need to select them on this setup procedure window.

The **CH1-CH8** output channels will be available on the **AD LINK 1** socket, while the **CH9-CH13** channels will be available on the **AD LINK 2** socket.

**Remark:** remember to assign the corresponding Amp ID to the specific amplifier. The bit One HD Virtuoso will automatically recognize the identified amplifier.

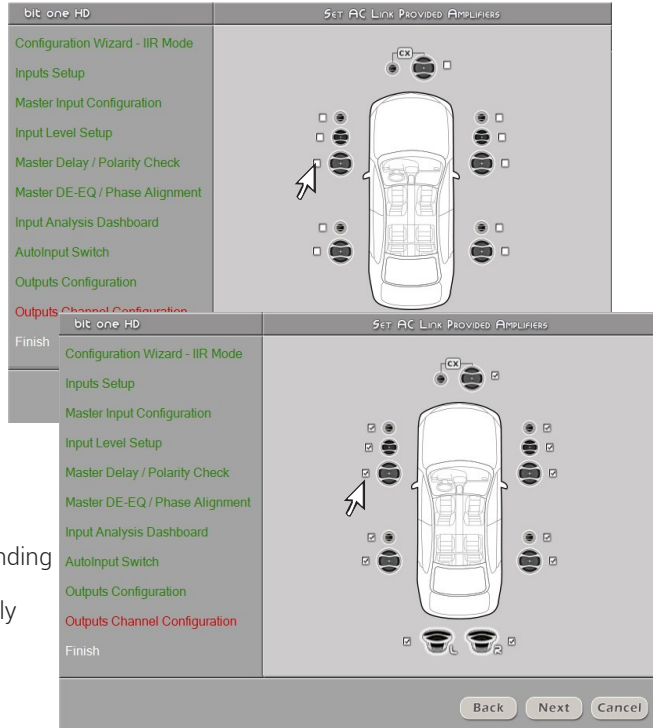

### 13. Finish

System configuration successfully completed. Stop playing the Test track, remove the supplied Setup CD from the head unit CD player and then press **OK**.

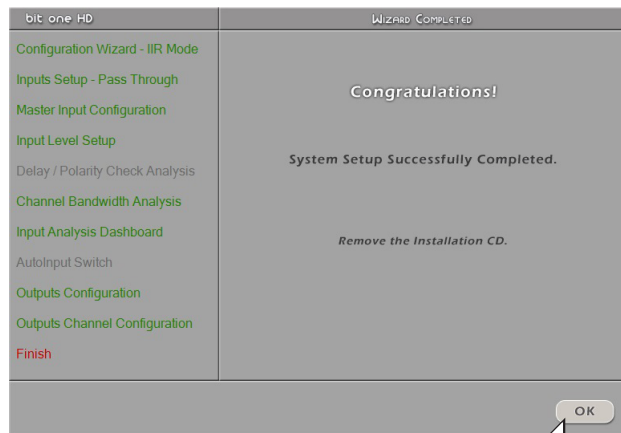

7.2.3 PASS THROUGH



The selection of I/O configuration using the "PASS THROUGH" allows the interface in direct configuration between inputs and outputs. Moreover, during the guided procedure it allows to divide the emission front in order to increase the number of existing ways per front. The peculiarity of this configuration is that it does not provide any equalization, correction of time delays, phase variations and channel sums, allowing subsequently only to intervene on time and phase alignment equalization for the Master input. When using the other auxiliary inputs (AUX, Optical 1/2) it is also possible to separate the Master setup by creating one that performs better than the limits set by the OEM system.

**Remark:** if the Master configuration features Rear Surround channels, during the selection of the auxiliary inputs these will not be available. The procedure must be performed by selecting which memory to assign the Master Pass-Through input from the start.

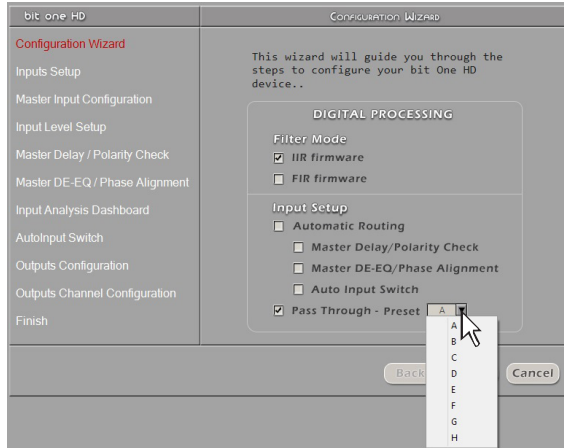

1. Inputs selection

- The type of input available for Pass-Through mode is High level. This type of approach has the function of being able to maintain all the audio features of the OEM system.
- Press **BACK** to go back to the previous step.
- Press **NEXT** to continue with the configuration.
- Press **CANCEL** to exit.

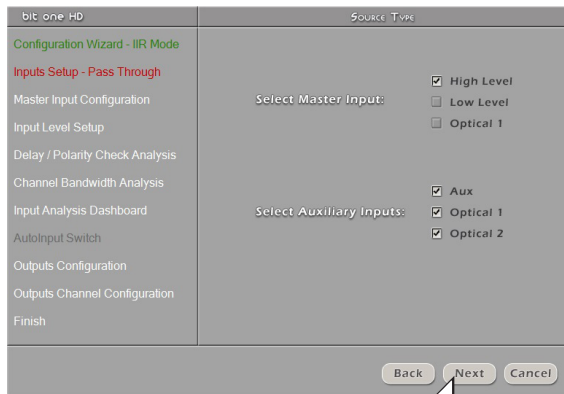

2. Analog inputs configuration

The inputs can be selected by clicking on the system's loudspeakers assigning the corresponding channel number. Based on the analog input type there will be 12 input channels to be manually customized. In Pass-Through mode it will be possible to interface with 5.1/7.1 factory systems without losing any functions of the dolby digital systems.

- Press **BACK** to go back to the previous step.
- Press **NEXT** to continue with the configuration.
- Press **CANCEL** to exit.

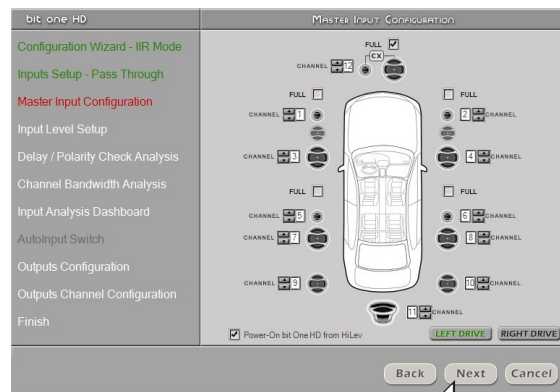

### 3. MASTER analog inputs levels calibration

Calibration is absolutely required to adapt the bit One HD Virtuoso inputs sensitivity to the signal coming from the source.

- Press **BACK** to go back to the previous step.
- Press **NEXT** continue with the inputs calibration.
- Press **SKIP** to bypass the inputs calibration procedure.

Follow the instructions listed below:

- Insert the supplied CD.

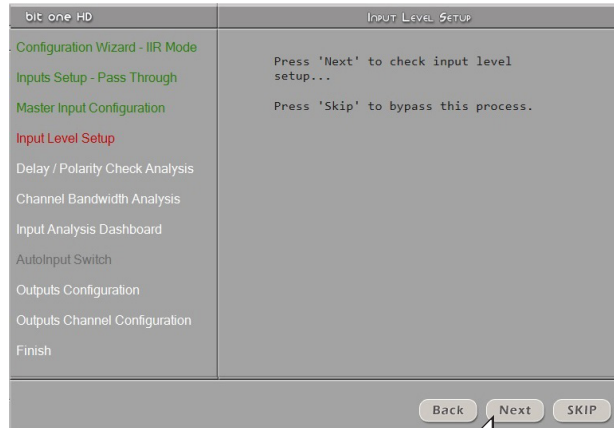

- Select the type of Test tracks contained in the USB device "SETUP31" (supplied with the product) according to your source (Head Unit), as shown below.
- "Wav Test Tracks Setup" folder if your source can play Wav format files.
- "MP3 Test Tracks Setup" folder if your source can not play Wav format files but only MP3.
- "5\_1 Test Tracks" Folder if your source can play 5.1 multimedia files.

**Remark:** the different types of tracks are available and downloadable from the Audison website ([www.audison.eu](http://www.audison.eu)), in the download section of the product bit One HD Virtuoso.

- Play track 1 (press Play);
- Set all tone controls to zero (0);
- Set balance and fader to center (0);
- Press **BACK** to go back to the previous step.
- Press **NEXT** to continue with the configuration.
- Press **CANCEL** to exit.

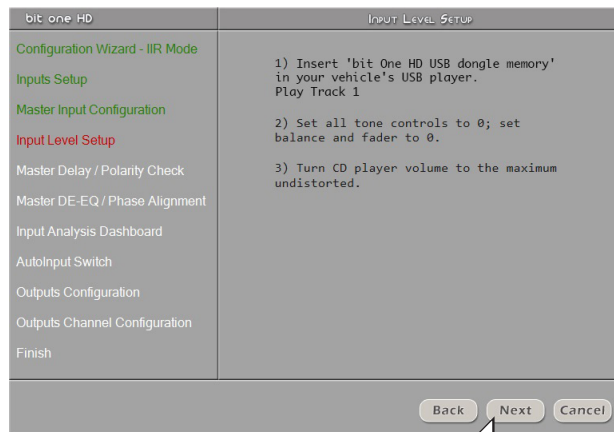

**Remark:** the calibration is essential to adapt the bit One HD Virtuoso sensitivity to the signal coming from the source.

**Important Remark:** the head unit level must be elevated to the maximum undistorted level. If the head-unit level can not be tested in advance, bring the volume adjustment to approximately 80% of its maximum excursion. If the head-unit output level is set at a lower level the bit One HD Virtuoso will produce a ground noise (hissing sound). Should such noise come from the bit One HD Virtuoso during reproduction, the calibration procedure will need to be repeated at higher volume.

#### 4. Input level automatic calibration

A progress bar and specific messages show the procedure's implementation.

Once the procedure is completed, the window will show the message "Press Next to Continue".

- Press **BACK** to go back to the previous step.
- Press **NEXT** to continue with the configuration.
- Press **CANCEL** to exit

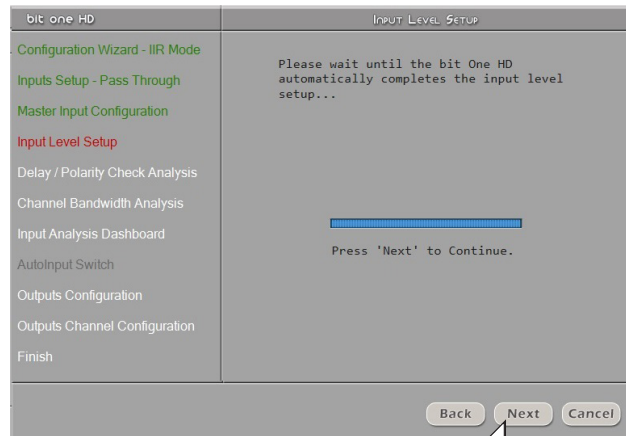

Once the procedure is completed the window will show the sensitivity levels setup according to the source interfaced with the bit One HD Virtuoso. This window is active and a further manual sensitivity adjustment can be performed

#### Select:

- Ref: 0dB Reference setup referring to the use of music tracks recorded at 0dB.
- +3dB - +6dB: referring to the Use of music tracks recorded at a level **lower** than 0dB (-3dB ÷ -6dB).
- Press **BACK** to go back to the previous step.
- Press **NEXT** to continue with the configuration.
- Press **CANCEL** to exit.

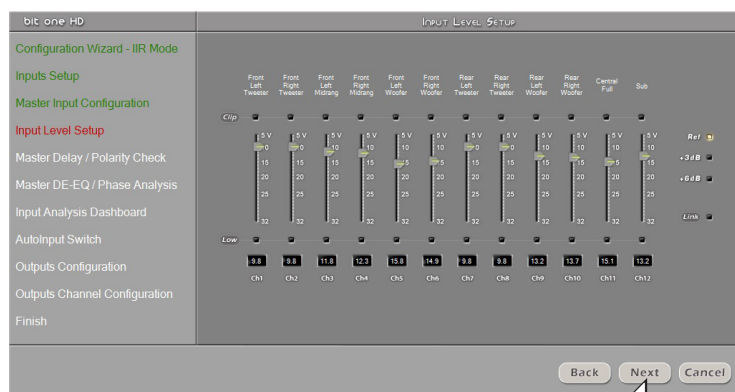

#### ERROR MESSAGE MAY APPEAR

##### "Input Level too low"

Should a message informing the user that the input signal is too low "Input too low" appear when the inputs calibration is completed, proceed as follows:

- Press **BACK** to go back to the previous step, check the inputs connection to the bit One HD Virtuoso and repeat the calibration procedure.
- Press **NEXT** to continue with the configuration, check the inputs connection. And then proceed with the manual sensitivity calibration (see section 8.11).
- Press **CANCEL** to exit



### 5. Master Input Delay / Master Input Polarity

The presence of time delays on the inputs of the **Head Unit** interfaced to the bit One HD Virtuoso can be verified as well as any phase inversions of the applied signal. This operation in PASS THROUGH mode has no corrective action, it is only used to check the system status.

- Press **BACK** to go back to the previous step.
- Press **NEXT** to continue with the configuration.
- Press **CANCEL** to exit.

Follow the instructions listed below:

- set all tone controls to zero (0);
- set balance and fader to center (0);
- do not change the volume level previously set through the inputs level automatic calibration;
- play track 3 (press Play);

- Press **BACK** to go back to the previous step.
- Press **NEXT** to continue with the configuration.
- Press **CANCEL** to exit.

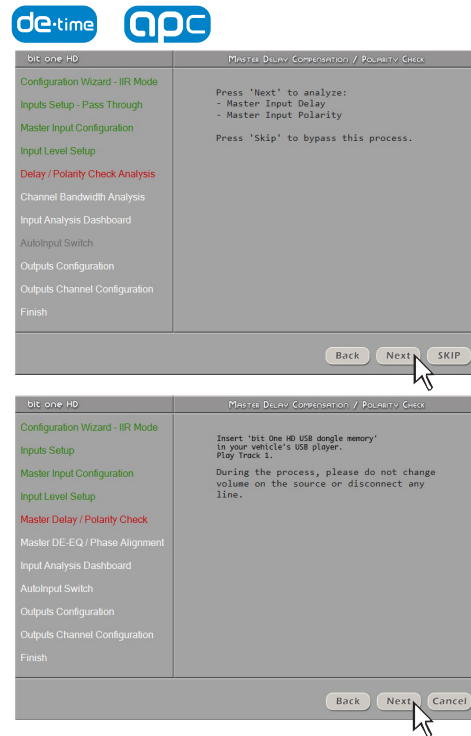

### 6. Channel Bandwidth Analysis

The analysis procedure of the emission front performs a study of the electrical frequency response coming from the source's various channels. This operation is necessary to be able to reconstruct the exits at the subsequent points following the trends of the inputs.

- Press **BACK** to go back to the previous step.
- Press **NEXT** to continue with the configuration

#### - Analysis of the emission fronts.

The analysis procedure of the emission front performs a study of the electrical frequency response coming from the source's various channels. This operation is necessary to be able to reconstruct the exits at the subsequent points following the trends of the inputs:

- a. OEM source equalization response;
- b. Electric response of the channel filters that make up the front;
- c. Display of the time delays of each individual channel of the emission fronts.

And follow the instructions listed below:

- set all tone controls to zero (0);
- set balance and fader to center (0);
- do not change the volume level previously set through the inputs level automatic calibration;
- play track 2 (press Play);
- Press **BACK** to go back to the previous step.
- Press **NEXT** to continue with the configuration.
- Press **CANCEL** to exit.

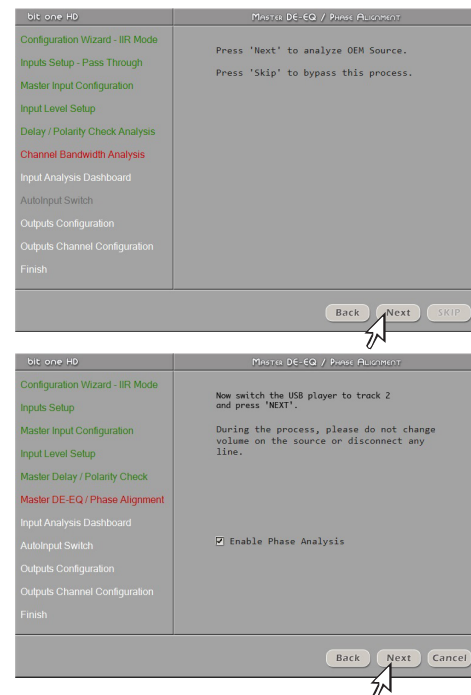

## 7. INPUT Analysis Dashboard

At the end of the procedure the results of the analysis of the interfaced source fronts will be displayed. The frequency trend of the signal will be displayed (Master EQ), and the trend of any input filters (XOVER) present. Clicking on each individual chart on the front, it will be possible to enlarge the trend of each individual front. This window can also display the presence of time delays of the source if any.

**Remark:** this operation has no corrective effect, it is only an analysis.



- Press **BACK** to go back to the previous step.
- Press **NEXT** to continue with the configuration.
- Press **CANCEL** to exit.

### 8. Selection of the speakers available in the system

Speakers can be selected just by clicking on them. The software assumes that if you select left tweeters, midrange or woofers, the right ones will also be activated automatically. This choice will affect, once the software is started, the type of dedicated virtual crossover.

**Remark:** if you selected the FIR mode the bit One HD Virtuoso will have a maximum of 9 out channels to enable.

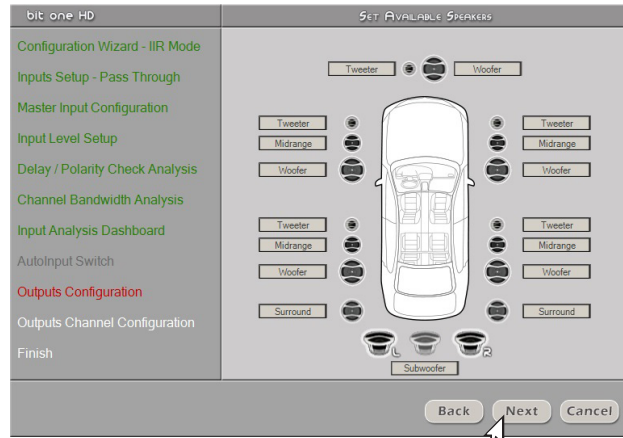

### Pass through 1:1

In this configuration the number of output channels is equal to the number of input channels. So if you have 8 channels in input it will be possible to have a system with 8 channels in output. The Software, however, will make other speakers available to increase the ways [\(see following point\)](#).

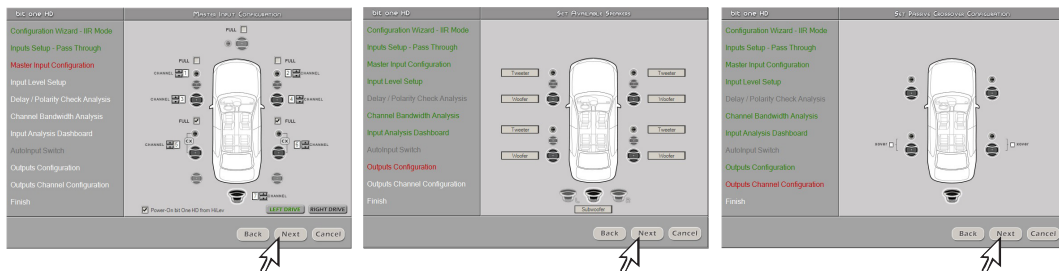

### Extended PASS THROUGH

In this configuration compared to the previous one it was decided to extend the number of output channels with respect to the same input configuration. In fact we would have 3 channels Front Out stereo, and 2 channels Rear out Stereo compared to a Real Full stereo system.

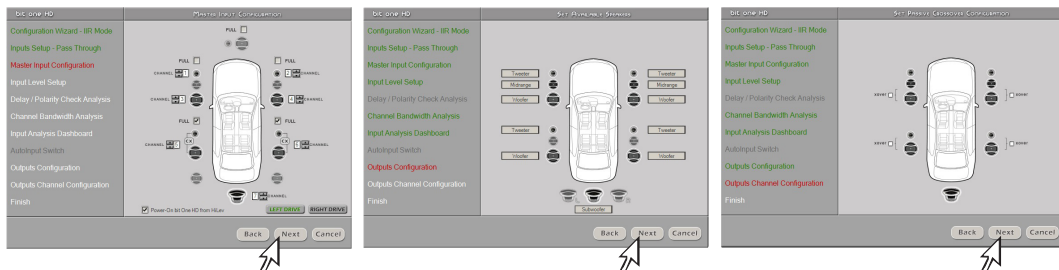

At the end of the setup

- Press **BACK** to go back to the previous step.
- Press **NEXT** to continue with the configuration.
- Press **CANCEL** to exit.

### 9. Selection of passive crossovers for speaker groups

The presence of passive crossovers managing speaker functional groups in complex systems can be provided by the user.

**E.g.:** the 3-way Front can be managed as:

- multi-amplified (6 output channels would be required);
- passive mid-high speakers + separately amplified woofer (4 output channels would be required);
- 3-way passive (2 output channels would be required).

While performing the setup, the software will automatically notify the return within the 13 output channel limit, the warning message will then disappear and the **NEXT** button will appear.

Press **BACK** to go back to the previous step.

Press **NEXT** to continue with the configuration.

Press **CANCEL** to exit.

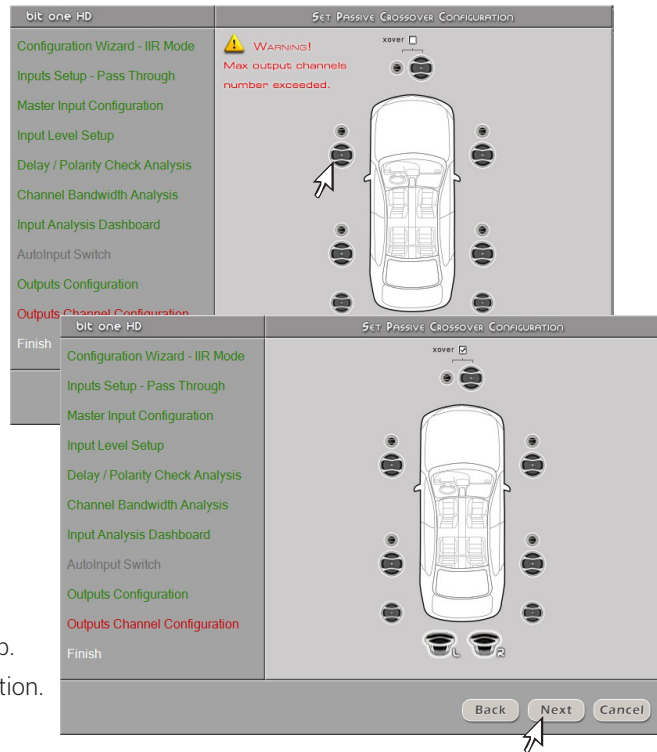

### 10. Processor outputs (Ch1-Ch13 IIR MODE) allocation.

The bit One HD Virtuoso features 13 output channels. On this specific step of the procedure, any signal can be assigned to each output channel.

**E.g.:** the outputs 1 and 2 can be assigned to the rear channels simply to avoid having to lengthen the cables going to the specific amplifier.

For a matter of convenience, if the output 1 is assigned to the left woofers, the software will automatically assign the output 2 to the right woofers. If during the procedure the output 1 is assigned also to the left mid-high speakers, the software will show a warning message. Change the allocation of one of the two numbers marked in red and the software will automatically select the first available channel.

Press **BACK** to go back to the previous step.

Press **NEXT** to continue with the configuration.

Press **CANCEL** to exit.

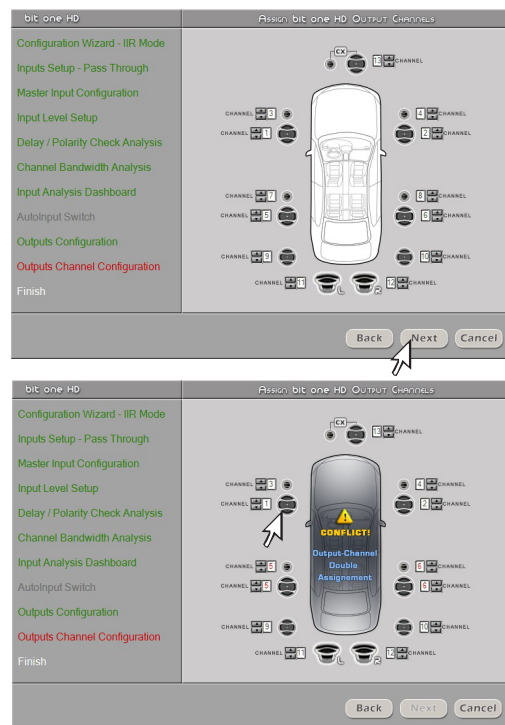

### 11. Selection of the amplifiers connected through the AD Link / AC Link connection system

If the system features amplifiers provided with the **AD Link** digital input and you want to connect them to the system, you need to select them on this setup procedure window.

The **CH1-CH8** output channels will be available on the **AD LINK 1** socket, while the **CH9-CH13** channels will be available on the **AD LINK 2** socket.

**Remark:** remember to assign the corresponding Amp ID to the specific amplifier. The bit One HD Virtuoso will automatically recognize the identified amplifier.

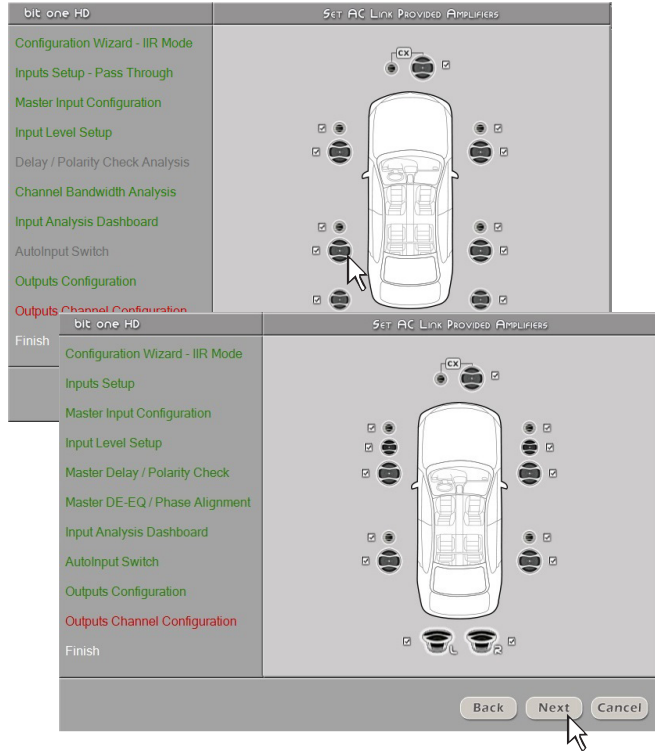

### 12. Finish

System configuration successfully completed. Stop playing the Test track, remove the supplied Setup CD from the head unit CD player and then press **OK**.

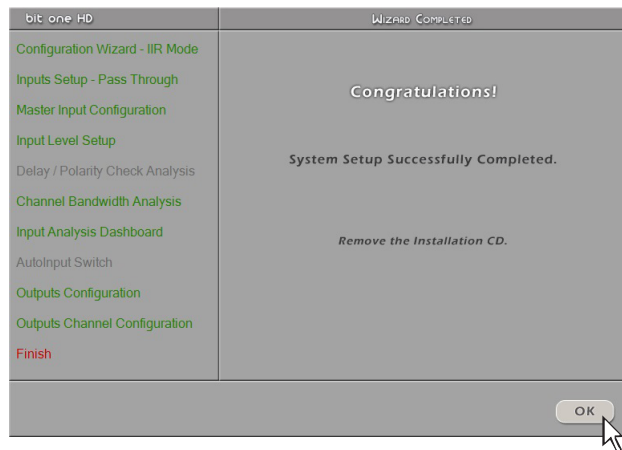

### 7.2.4 MASTER INPUT OPTICAL 1

If you choose to activate the Optical 1 input as the Master input of your source, and this does not have an output volume control, this operation is essential to be able to adjust the volume from your audio source. For connections, refer to [section 5.4.3 - 5.6.1](#) of this manual and proceed as follows.

#### 1. Auto Input Switch

The automatic volume control for the auxiliary source (Aux - Optical 1/2) can be activated through the Head Unit volume control, if it is provided with an AUX input ([see section 5.4.3, 5.6.1; 8.3.5](#)). If the car HEAD UNIT does not feature an analog AUX input, connect the USB RVA device supplied with the product to the USB player of your audio source as shown in [sections 5.4.3; 5.6.1](#). The USB device contains the ready-to-use 16.5KHz.MP3 (default) file, but it is possible to choose one of the other tones found in the compressed folder during the calibration ([see section 8.3.5](#)).

If a USB reader is not available, you can copy the tone to be used for automatic switching from the supplied USB RVA device to an SD Card type storage device. Please note that the storage device must contain only this file and no other files. If you use the USB memory to activate the switching via the RVA function, just select the USB (SD) input of the main source (Head Unit).

- Press **BACK** to go back to the previous step.
- Press **NEXT** to continue with the configuration.
- Press **SKIP** to skip the procedure, or if you want to use the USB RVA device.

Follow the instructions listed below:

- 1) Use of the Head Unit AUX input:
  - connect the Head Unit AUX IN inputs to the RVA connector of the bit One HD Virtuoso using the appropriate cable.
  - select the source AUX IN input (Head Unit).
  - set the source volume to the maximum undistorted level.
- 2) Use of the Head Unit USB input:
  - Press NEXT and then adjust the RVA function settings as per [section 8.3.5](#).

At the end of the procedure:

- Press **BACK** to go back to the previous step.
- Press **NEXT** to continue with the configuration.
- Press **CANCEL** to exit.

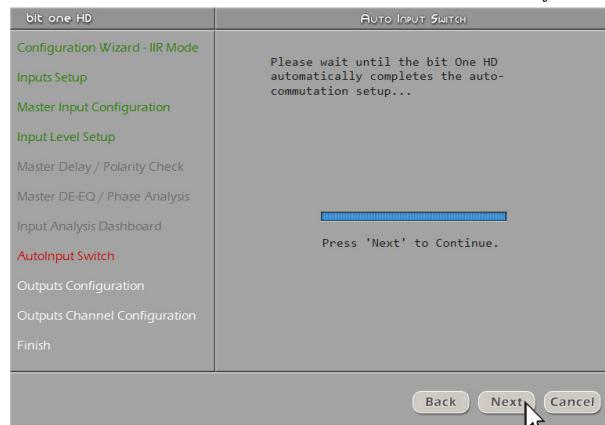
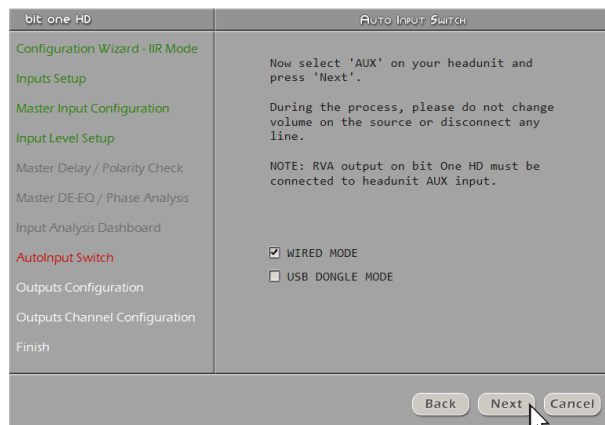
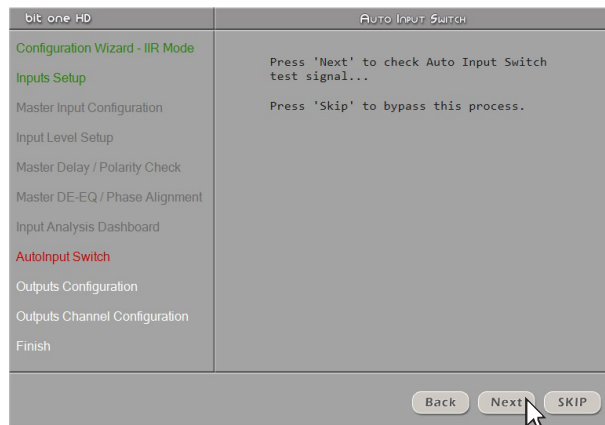

## 2. Selection of the speakers available in the system

Speakers can be selected just by clicking on them. If the left tweeter, left midrange or left woofer are selected, the software provides the ability to automatically activate also the right tweeter, right midrange or right woofer. Once the software is started, this choice will affect the dedicated crossover type.

**E.g.:** if on the rear system only the woofers are activated, the software will only show a low-pass or band-pass filter as available. If you want to use a coaxial system as rear channel, both tweeter and woofer need to be selected and then you need to specify that a passive crossover is connecting them, so the software will show a high-pass filter as available.

**Remark:** if you decided to use the FIR mode the bit One HD Virtuoso will avail of a maximum of 9 output channels to be enabled.

From this point onwards a simulation of a system with the following components will be used:

- 3-way Front active
- 2-way Rear active
- 2-way center passive
- Stereo Sub

All 13 output channels of the **bit One HD Virtuoso** in IIR mode will be used.

- Press **BACK** to go back to the previous step.
- Press **NEXT** to go ahead with the configuration.
- Press **CANCEL** to exit.

**Remark:** Audio systems with at least 4-way front or 3 Rear are not fully compatible with AV bit In and bit Tune.

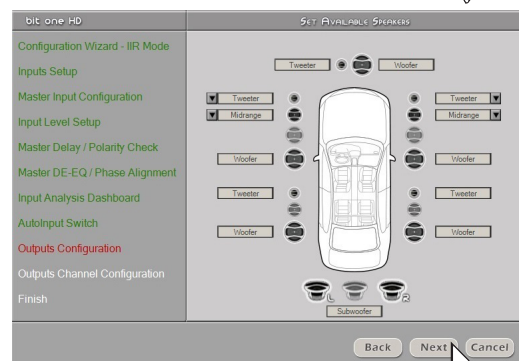
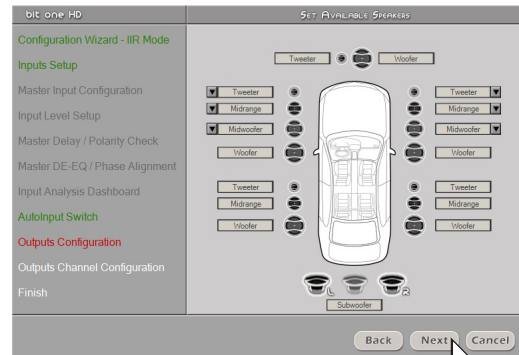

Window for the selection of the speakers available in the system

## 3. Selection of passive crossovers for speaker groups

The presence of passive crossovers managing speaker functional groups in complex systems can be provided by the user

**E.g.:** the 3-way Front can be managed as:

- multi-amplified (6 output channels would be required);
- passive mid-high speakers + separately amplified woofer (4 output channels would be required);
- 3-way passive (2 output channels would be required).

While performing the setup, the software will automatically notify the return within the 8 output channel limit, the warning message will then disappear and the **NEXT** button will appear.

Press **BACK** to go back to the previous step.  
Press **NEXT** to continue the configuration.  
Press **CANCEL** to exit.

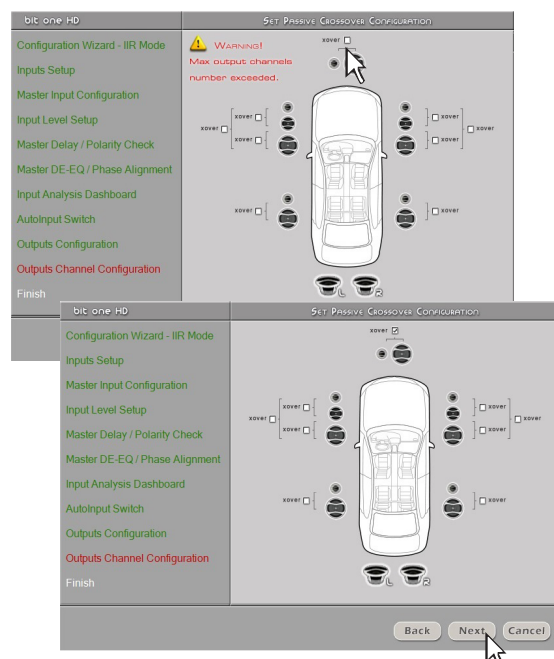

#### 4 Processor outputs (Ch1÷Ch13 IIR MODE) allocation

The bit One HD Virtuoso features 13 output channels. On this specific step of the procedure, any signal can be assigned to each output channel.

**Eg.:** the outputs 1 and 2 can be assigned to the rear channels simply to avoid having to lengthen the cables going to the specific amplifier.

For a matter of convenience, if the output 1 is assigned to the left woofers, the software will automatically assign the output 2 to the right woofers. If during the procedure the output 1 is assigned also to the left mid-high speakers, the software will show a warning message. Change the allocation of one of the two numbers marked in red and the software will automatically select the first available channel.

Press **BACK** to go back to the previous step.  
 Press **NEXT** to continue with the configuration.  
 Press **CANCEL** to exit.

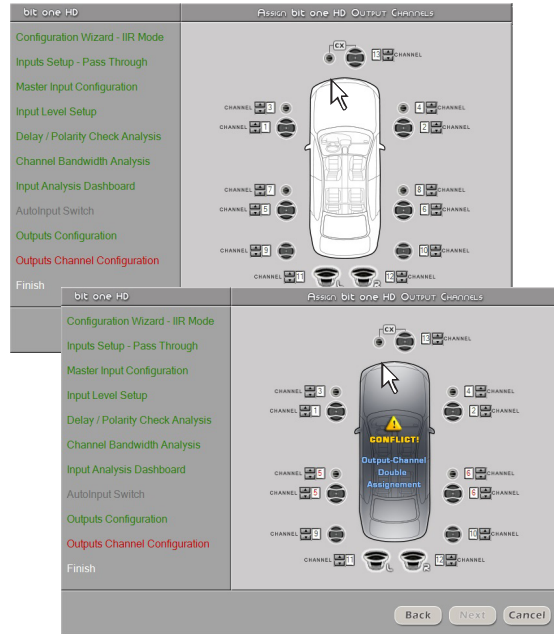

#### 5. Selection of the amplifiers connected through the AD Link / AC Link connection system.

If the system features amplifiers provided with the AD Link digital input and you want to connect them to the system, you need to select them on this setup procedure window.

The **CH1-CH8** output channels will be available on the AD LINK 1 socket, while the **CH9-CH13** channels will be available on the **AD LINK 2** socket.

**Remark:** remember to assign the corresponding Amp ID to the specific amplifier. The bit One HD Virtuoso will automatically recognize the identified amplifier.

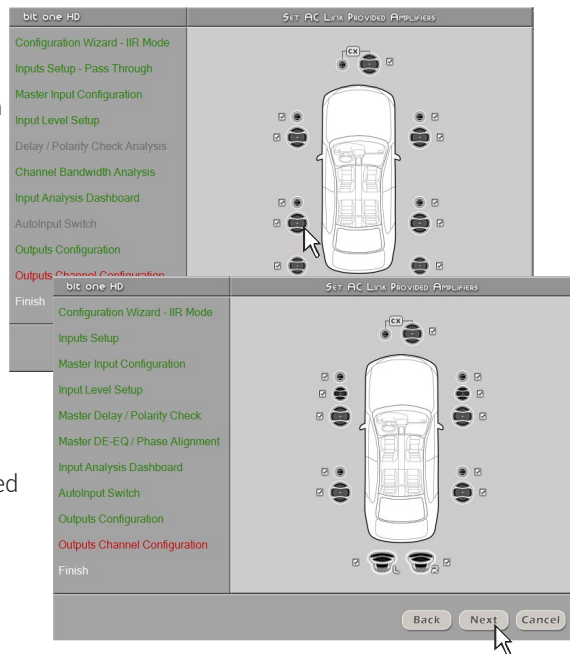

## 6 System configuration successfully completed

Stop playing the Test track, remove the supplied Setup CD from the head unit CD player and then press **OK**.

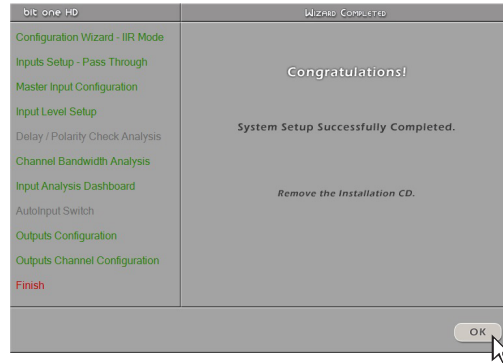

## 8. bit One HD Virtuoso SETUP USING A PC

### Software Start Up

The software transfers the settings selected during the guided procedure to the processor main memory.

For the first connection of the bit One HD Virtuoso to a PC, we recommend to **FINALIZE** the bit One HD Virtuoso, to avoid losing the data stored when performing the auto-setup process (see section 8.2.3).

At this stage the bit One HD Virtuoso is provided with the appropriate basic setup. In the following chapters the features allowing acoustic tuning of the system will be detailed.

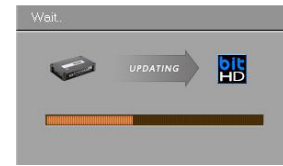

**WARNING:** we recommend that you do not modify the settings of your bit One HD Virtuoso to explore its different features. Take your time to get familiar with the possibilities this software offers. The settings applied to the bit One HD Virtuoso have immediate effect on the signal. Should these settings not be performed with the due attention, they may cause damage to the system speakers.

**If you decide to leave the amplifiers connected to the bit One HD Virtuoso, remember to perform the adjustments keeping the general volume at a level which does not damage the speakers in your system.**

### 8.1 FEATURES

The following pages describe the bit One HD Virtuoso features that can be managed using the software.

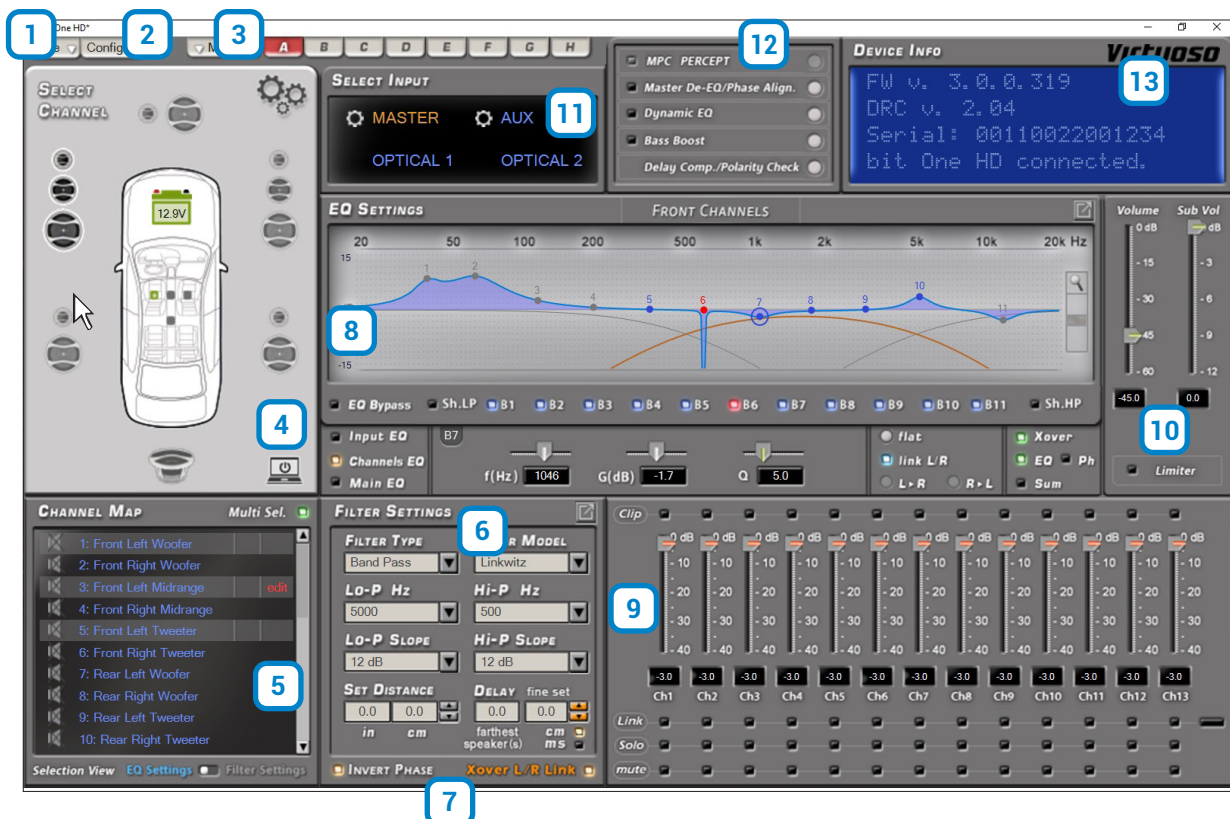

**8.2 MAIN MENU: "FILE" 1**

Selecting the "File" tab a drop-down menu shows up listing the entries as shown in the image to the right of this page:

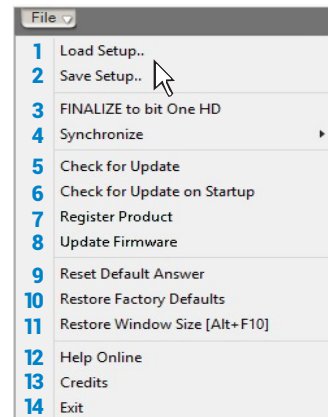

**1. Load Setup:** by selecting this entry, the bit One HD Virtuoso entire setup is loaded from a previously saved file (EX. "BitOnehdConfig1.bhd"). This feature is available both in **TARGET** and **OFFLINE** mode. In **TARGET** mode this function provides the ability to load again all the settings that have been previously saved. It is useful if you want to resume all the settings you have previously selected to install another bit One HD Virtuoso with the same adjustments, in order to test different acoustic settings.

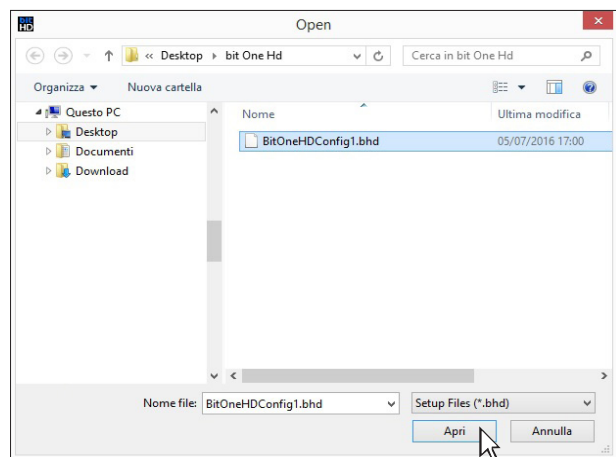

The software allows the user to upload a file saved in FIR mode in IIR mode, converting the equalization curves of the Channels EQ and maintaining the settings of the inputs and the specialization of the outputs. Obviously when going from FIR to IIR small adjustment setups are necessary concerning the electrical phases of the output channels (Invert Phase). The reverse operation, loading an IIR file in FIR mode, is not contemplated.

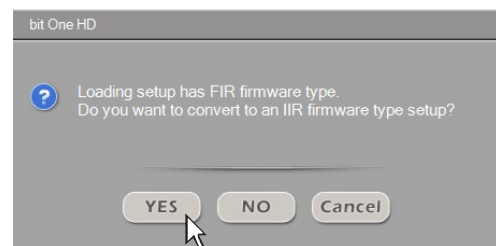

- Select **YES** to load a FIR setup in IIR mode.
- Select **NO** to load a FIR setup.
- Select **Cancel** to cancel the operation.

**2. Save Setup:** it enables the storage of the entire bit One HD Virtuoso configuration in a file (EX. BitOnehdConfig1.bhd") that you can subsequently load into the bit One HD Virtuoso through the Load Setup function. This feature is available both in **TARGET** and in **OFFLINE** mode.

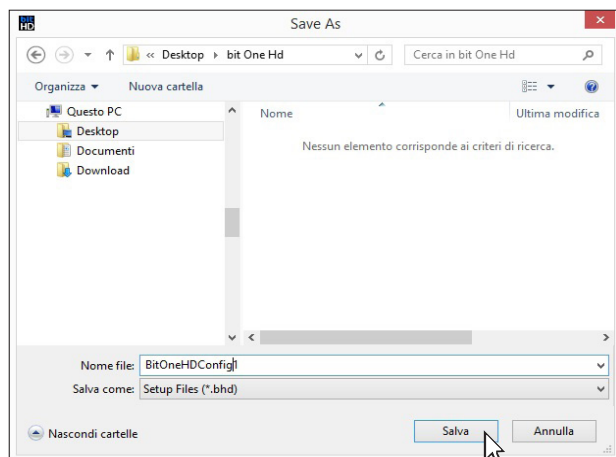

**3. FINALIZE TO BIT ONE HD VIRTUOSO:** this function enables the loading of all the parameters selected while configuring the bit One HD Virtuoso microprocessor internal memory, allowing it to work without being connected to a PC. When selecting the Finalize to bit One HD Virtuoso function, the software notifies that the data previously saved in the bit One HD Virtuoso will be overwritten.

- Select **YES** to load the data saved in the bit One HD Virtuoso, overwriting the previously saved data, if any.
- Select **NO** to interrupt the process.

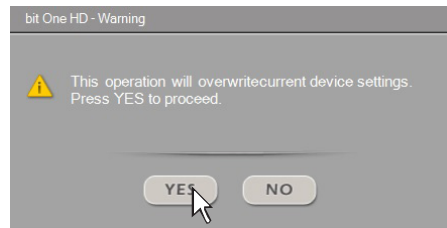

**WARNING:** before disconnecting the **bit One HD Virtuoso** from the PC or each time that you exit the PC software after modifying the system configuration, always run the **Finalize to bit One HD Virtuoso** procedure. If you do not follow these instructions all the data entered will be lost.

**4. Synchronize, PC -> bit One HD Virtuoso or PC <- bit One HD Virtuoso:**

these functions synchronize the PC with the bit One HD Virtuoso. If a dialog box as the one to the right of this page shows up, it means that for some reason communication between the PC and the bit One HD Virtuoso has been interrupted. To restore the communication select:

- **PC -> bit One HD Virtuoso.** The PC loads the settings selected so far in the bit One HD Virtuoso.
- **PC <- bit One HD Virtuoso.** The PC loads the settings previously stored in the bit One HD Virtuoso on the PC software.

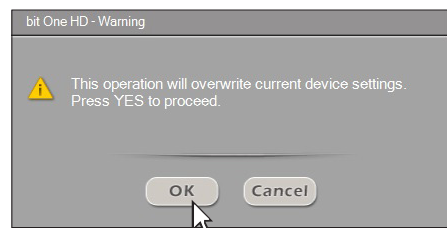

**WARNING:** this operation can not guarantee that the data are always retrieved. If the operation is not successful:

1. exit the bit One HD Virtuoso software.
2. turn the bit One HD Virtuoso off.
3. turn the bit One HD Virtuoso on.
4. launch the bit One HD Virtuoso software again.

By performing these actions, synchronization will be restored but the selected settings will be lost.

5. **Check for updates:** it enables the connection to the website "[www.audisonbitdrive.eu](http://www.audisonbitdrive.eu)" to check if any software / firmware updates for the bit One HD Virtuoso are available (see section 9.3). To perform this operation, your PC has to be connected to the internet.
6. **Check for Updates on Startup:** when enabled, the software automatically checks the availability of new Firmware/PC software updates each time the program is started (see section 9.3).
7. **Register product:** this function requires an internet connection and opens the default browser to the page for registering the product and creating a personal account in the "bit Drive" portal. This operation only needs to be performed once; then you can access your account through the Account Login (see section 9.3).
8. **Update Firmware:** function to update the bit One HD Virtuoso firmware (see section 9.3).
9. **Reset Default Answer:** it restores the display of the warning messages if they have been disabled by ticking "Don't show me again".

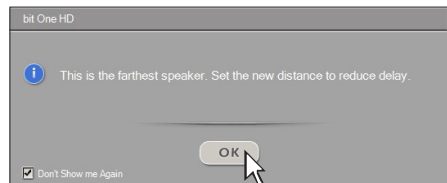

**10. Restore Factory Defaults:** it entirely resets the bit One HD Virtuoso back to its default settings, cancelling all the data previously saved in the bit One HD Virtuoso (see section 8.2.2).

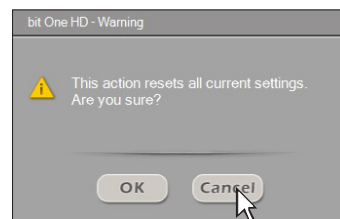

**WARNING:** during this procedure the bit One HD Virtuoso RCA / AD LINK - AC LINK outputs to the amplifiers should be disconnected.

- 11. Restore Window' Size:** this functions performs the re-sizing of the PC software window to the default dimension. Re-sizing can also be performed through the PC keyboard, using **ALT+F10**.
- 12. Help Online:** this function requires an internet connection. By activating this function and moving the mouse pointer to the various sections of the graphic interface for the PC software, the concerned area will be highlighted in red. By clicking on the red area, a link will activate, opening up the default browser, displaying the paragraph of the manual related to that specific area. The manual will be displayed in the language selected in **CONFIG->Language**.
- 13. Credits:** it shows the information about the bit One HD Virtuoso software in use.
- 14. Exit:** to exit the PC Software.

### 8.3 MAIN MENU: "CONFIG" 2

Selecting the "Config" tab a drop-down menu shows up listing the entries as shown in the image to the right of this page:

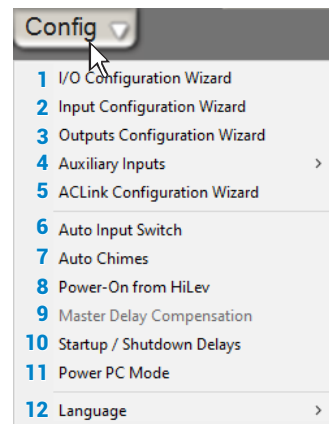

- 1. I/O Configuration Wizard:** it provides the ability to perform a new auto-setup, providing the bit One HD Virtuoso with the conditions required to run this operation (see section 7.2).
- 2. Input Configuration Wizard:** this function allows for the calibration of the bit One HD Virtuoso inputs only, without modifying the outputs configuration (see section 7.2).
- 3. Output Configuration Wizard:** This function allows you to perform a new configuration of the bit One HD Virtuoso outputs, without modifying the configuration of the inputs made previously (see section 7.2.2.9).
- 4. AC LINK Configuration Wizard:** this function allows to activate or deactivate the AC LINK outputs, once the setup is completed by interacting on the "Outputs Channel Configuration".

Below is a description of how to proceed, remembering to set the volume of the processor to -60dB.

- 1. Disable the AC LINK outputs.**
  - Deselect the AC LINK outputs you do not want to use from the Channel Map, then press OK.
  - Finalize the Product using the "Finalize to bit One HD Virtuoso" function.
- 2. Enable AC LINK outputs.**
  - Select the AC LINK outputs you want to use from the Channel Map, then press OK.
  - Finalize the Product using the "Finalize to bit One HD Virtuoso" function.
  - Close the PC software, turn off and restart the audio system.
  - Configure your amplifiers equipped with an AC LINK interface, based on the digital channels assigned. To complete the setup of the amplifiers equipped with AC LINK input, it is essential that the DRC MP is connected to the bit One HD Virtuoso.
  - Open the PC software and proceed with the setup of the audio system.

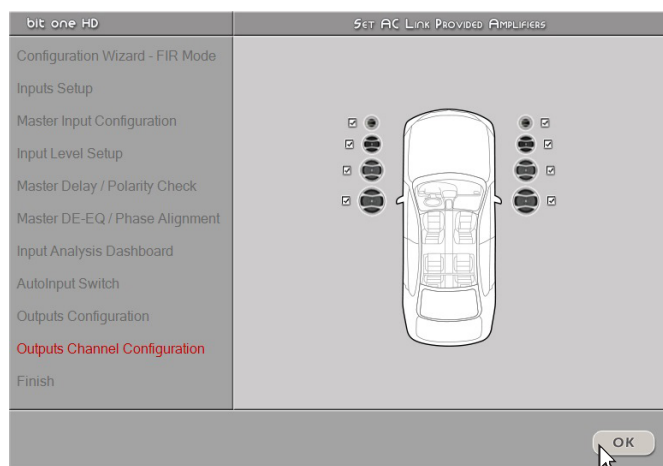

- 5. Auxiliary Inputs:** it provides the ability to enable or disable auxiliary sources which have been or have not been selected while performing the setup (see section 7.2.1), without repeating the calibration procedure.

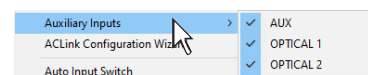

## 6. Auto Input Switch

- **OPTICAL AUDIO SWITCH.** By activating this function it is possible to automatically select one of the two optical inputs available in the Virtuoso, provided there is an audio signal.

**A. Optical 1 Audio Detect:** through this function it is possible to automatically activate the Optical 1 or Optical 2 input if an audio signal is present. In the event that the Optical 1 input is used as "Master Input Optical", this will not be available for this function.

**B. Current Source to Optical 1:** Current Source to Optical: to set the activation time of the Optical input selected in the previous point. By default the switching time is set to 42.67 ms but it is possible to set it up to 5440 ms (5.4 seconds). If there are spurious switching towards the Optical 1 input, the switching time can be increased to eliminate it. If the switching to Optical 1 is too slow, the switching time can be decreased to speed it up.

**C. Optical 1 to Current Source:** to set the deactivation time of the selected Optical input activated automatically (see point A). By default the switching time is set to 106 ms but it can be set to a maximum of 27200 ms (27 sec). By acting on this parameter you can speed up or slow down the switching to the previously disabled input.

**D. Threshold:** to set the minimum threshold level of the Optical input signal to be enabled. It is possible to choose between intervention levels from 0 dB to -96 dB.

● **RVA:** this function provides the ability to select an auxiliary input of the bit One HD Virtuoso: Optical 1, Optical 2, AUX and possibly control the volume from an external source provided with an AUX input. To use this function it is necessary to perform the calibration during the I/O Configuration Wizard phase ([see section 8.3.1](#)) and connect the bit One HD RVA input, as described in [sections 5.4.3 e 5.6.1](#).

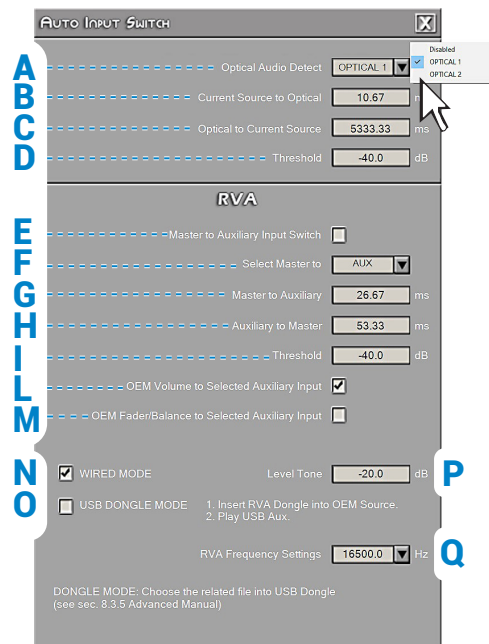

### USE OF THE HEAD UNIT AUX INPUT

The switch between the bit One HD Master and auxiliary inputs (Aux, Optical 1/2) is completed by selecting the analog Aux input from the main source (Head Unit) and the volume will be controlled by the latter.



Switch via analog AUX input

### USE OF THE HEAD UNIT AUX USB INPUT

If the vehicle HEAD UNIT does not feature an analog AUX input, connect the USB RVA (INCLUDED WITH THE PRODUCT) as shown in [see section 5.4.3: 5.6.1](#), to your head unit multimedia player. The USB RVA device provided contains the MP3 16.5KHz file format (Default). Inside the USB RVA device, there are also other tones with other frequencies and different levels in .zip format that can subsequently be used during the setup phase according to specific needs. If a USB player is not available you can copy the tone necessary for automatic switching inside an SD Card storage device. We remind you that the storage device must only contain this file and no others, and during the reproduction it must not be paused or stopped!!!



Switch via USB/SD AUX input  
The information displayed vary depending on the source used.

**Remark:** the different types of tracks are available and downloadable from the Audison website ([www.audison.eu](http://www.audison.eu)), in the download section of the product bit One HD Virtuoso.

### Functions Description:

**E. Master to Auxiliary Input Switch:** select the flag to enable/disable the auxiliary source automatic switching function set up in point B.

**F. Select Master to:** function to enable the automatic selection of one of the three external sources available; AUX, Optical 1, Optical 2. Select the source to activate the AUX input of the system source (Head Unit).

- G. Master to Auxiliary:** function to set the starting time for the selected auxiliary input of the bit One HD ([see point 5](#)), through the "Auto Input Switch" function. By default the switching time is set to 13.33 (default value) but it can be set starting with a minimum of 13.33 ms up to a maximum of 680 ms. Should any undesired switching occur from Master to AUX, switching time can be increased to eliminate it. If the switching from Master to AUX is too slow, the switching time can be decreased to speed it up.
- H. Auxiliary to Master:** it enables the turn off of the selected auxiliary input of the bit One HD ([see point 5](#)), through the "Auto Input Switch" function. By default the switching time is set to 13.33 (default value) but it can be set starting with a minimum of 13.33 ms up to a maximum of 6800 ms (6.8 sec). Should any undesired switching occur from AUX to Master, the release time can be increased to eliminate it. If the switching from AUX to Master is too slow, the release time can be decreased to speed it up.
- I. Threshold:** function to set the auxiliary input signal minimum threshold previously selected, to activate it. The operation levels range from 0 dB to -96 dB.
- L. OEM Volume to Selected Auxiliary Input:** select the flag to adjust the audio system volume using the volume control on the Head Unit. The volume control from DRC is disabled when an auxiliary input of the bit One HD Virtuoso is activated through the "Auto Input Switch" function.
- M. OEM Fader/Balance to Selected Auxiliary Input:** select the flag to automatically adjust the audio system balance and fader through the OEM source, when an auxiliary input is enabled (see point B).
- N. WIRED MODE:** By default it is set to 16.5 KHz, but it can be varied depending on the Head Unit performance, from a minimum of 14KHz to a maximum of 22KHz. This frequency can not be heard since it is concealed by the processor, and it has the function to control the Master volume and the selection of the bit One HD Virtuoso auxiliary input. If malfunctions occur using RVA with the Analog AUX input of the Head Unit, choose the lowest available value, so that a good functional compromise is reached.
- O. USB DONGLE MODE:** When using a USB RVA device (supplied), this contains by default the tone "16500 hz -6dB", as set in the "Freq Tone" window. If malfunctions occur during the switching, proceed as suggested below:
  - 1)** Playback of audio files on the Auxiliary input (AUX / Optical) of the bit One HD Virtuoso does not reach maximum level:
    - Disconnect the USB RVA device from the source and insert it into a PC. Unzip the folder (.rar format) called "RVA 16.5KHz" in the desktop of your PC, and then copy the decompressed file "16.5 KHz -6dB", in the main route of the USB RVA device.
  - 2)** During the switching between Master input and Auxiliary input (AUX / Optical), annoying hisses can be heard:
    - Disconnect the USB RVA device from the source and insert it into a PC. Unzip the folder (.rar format) called "RVA 16.5KHz" in the desktop of your PC, and then copy the decompressed file "16.5 KHz -6dB", in the main route of the USB RVA device. If the problem still persists when re-inserting the USB RVA device in the USB reader of the Head Unit, copy the previously unzipped file "16500 hz -12dB" inside the USB RVA device.
    - If the instructions in the previous point do not have the desired effect, proceed as follows: Disconnect the USB RVA device from the source and insert it into a PC. Unzip the folder (.rar format) called "RVA 16.5KHz" in the desktop of your PC, and then copy the decompressed file "16.5 KHz -6dB", in the main route of the USB RVA device. Select the value "18000" in the "Freq Tone" window of the PC software. Car head units do not behave in the same way and it may be necessary to choose other tone values in order to achieve the optimal setting.  
 If an optimal control tone is reached to use the RVA function, further refinement can be carried out by acting on the input sensitivity of the Master source, varying the levels of all the input channels via the link function, within a permitted limit of  $\pm 3$ dB with respect to the calibration ([see section 8.11](#)).

**Remark:** if a USB reader is not available, you can copy the tone to be used for automatic switching from the supplied USB RVA device to an SD Card type storage device. Please note that the storage device must contain only this file and no other files.  
 The different types of tracks are available and downloadable from the Audison website ([www.audison.eu](http://www.audison.eu)), in the download section of the product bit One HD Virtuoso.

- P. Level Tone:** function to set the "Freq Tone" for the switch of the bit One HD Virtuoso auxiliary input. The Level Tone default value is set to a value calculated during the I/O Configuration Wizard. It is possible to select among 0 dB to -96 dB intervention levels, to optimize any spurious commutations compared to the automated calculation provided by the I/O Configuration Wizard.

**Remark:** this function is only active when the **RVA** function is used via the Head Unit Aux analog input.

- Q. RVA Frequency Settings:** function to select the switching tone of the bit One HD Virtuoso auxiliary input (AUX / OPTICAL 1 / OPTICAL 2), by connecting with the Head Unit AUX analog input or the USB multimedia device.

7. **Auto Chimes:** activate this function by ticking the **Enable** box to switch to the main Master input each time a "Gong Signal" coming from the car should be heard.

**Functions Description:**

- A. **Attack:** function to set the starting time for the auxiliary input to activate. The operation levels range from 13 ms to 680 ms.
- B. **Release:** function to set the turn off time of the auxiliary input activated. The operation levels range from 13 ms to 6800 ms.
- C. **Threshold:** function to set the minimum threshold level of the "Gong Signal" coming from the Head Unit Master input. The operation levels range from 0 dB to -96 dB.

8. **Power-On From HiLev:** select this entry to activate the bit One HD Virtuoso turn on using a high level signal (**ART, Auto Remote Turn On**), available on the **CH1** and **CH2** channels.

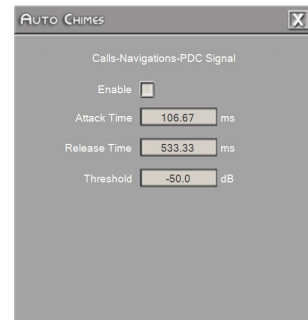

9. **Master Delay Compensation:** select this entry to enable/disable the Head Unit time delays compensation. This function is available if during the "I/O Configuration Wizard" phase the "Master Input Delay" procedure has been performed (see section 7.2.2.5).

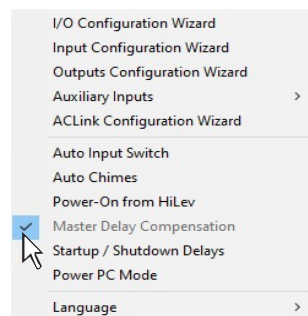
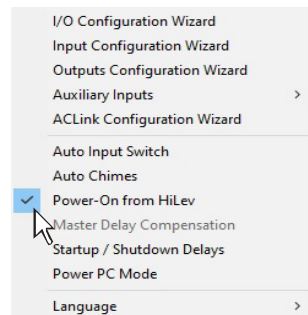

10. **Startup/Shutdown Delays:** function to modify the bit One HD Virtuoso startup and shutdown delays.

- **StartUp Time:** delay between the device startup and the output audio turn on. Each amplifier, when starting up, has its own delay before becoming operative. By setting the Startup Time to a value equal to or higher than the longest of these delays a synchronized startup of the audio of the entire system can be achieved.
- **Shutdown time:** delay between the turn off/deactivation of the REMOTE OUT signal to the amplifiers and the bit One HD Virtuoso shutdown. Acting on this parameter is not generally essential but it could be useful to decrease it when amplifiers in the system produce a "Bump" while shutting down.

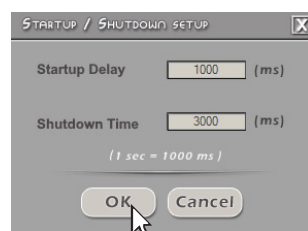

11. **Power PC Mode:** if this function is enabled, it does not allow the bit One HD Virtuoso to be switched off, if the audio system is accidentally switched off, or if it is automatically disabled by the car during calibration. This function will allow you to keep the changes made enabled and possibly save them, or switch the main system back on and continue with the setup.

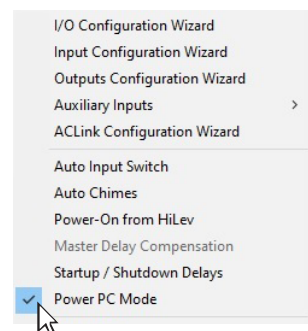

12. **Language:** to change the language select your preference among the ones available on the menu.

**8.4 MEMORY** **3**

The **bit One HD Virtuoso** manages the system setup working on Preset A by default; however, it also offers the possibility to store and recall eight Presets (**A, B, C, D,E,F,G,H**).

Pressing the MEMORY button on the main menu you can access the different functions you can perform on the featured presets.

The following functions are available:

- **Load All Presets:** it loads all the memories (A/B/C/D/E/F/G/H) from a file previously saved (.prs format);
- **Save All Presets:** it saves all the memories (A/B/C/D/E/F/G/H) in a file that can be recalled (.prs format);
- **Load Current Preset:** it loads a memory previously saved (.pro format) by placing it on the memory you are operating on;
- **Save Current Preset:** it saves the memory you are operating on in a file that can be recalled (.pro format);
- **Copy Preset From:** it provides the ability to copy the content of one memory into another memory;
- **Current Preset Default:** it restores the crossover and equalization default values, that would be suggested at the end of the set up procedure;
- **Enable Memory Overall:** it enables the Overall function which recalls a memory previously saved (see following point), optimized for a perfect listening from all positions within the car compartment. This function can be activated through the terminal, setting the Overall Sel cable to +12V ([see section 8.3.4](#));
- **Select Memory Overall:** it sets an existing memory as "Overall". Choose one of the memories where an Overall setup is set.

The following data will be stored into the presets:

- the filter settings for each channel;
- the time delay settings for each channel;
- the equalization settings for each output channel;
- the Main EQ settings ([see section 8.9.2](#));
- the Dynamic EQ settings/activation ([see section 8.12.3](#));
- the Bass Boost settings/activation ([see section 8.12.4](#));
- the output levels of each channel;
- listening points markers.

We recommend that you copy the parameters entered in the preset you are using into the presets that are not being used. The presets can be recalled through the DRC MP. If some presets are not stored, they will store the default settings.

**Pass through**

In Pass through mode there is only one memory, assigned in the "I / O configuration Wizard" phase, to the Master input. So when the Master input is selected will be available only one memory, and it will not be possible to copy other memories on it. The remaining memories and related functions will be available at the input change.

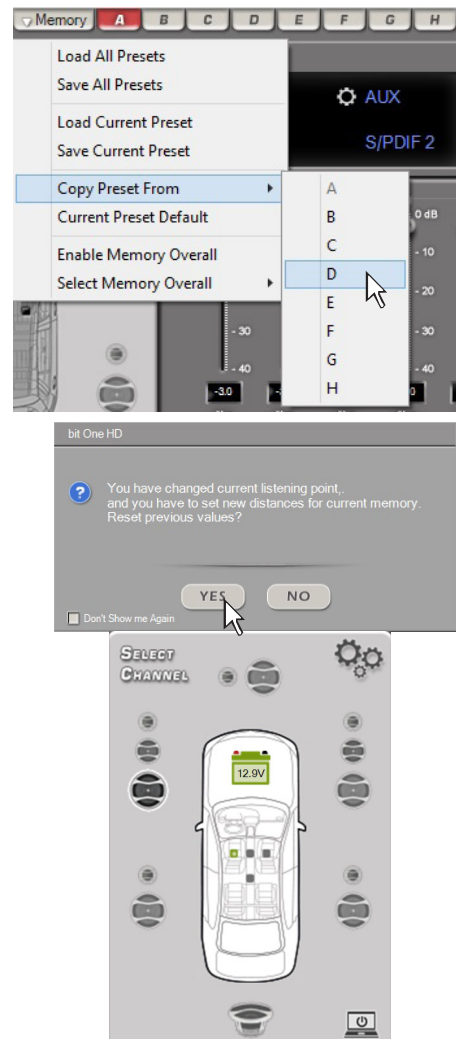

**8.5 SELECT A CHANNEL / BATTERY STATUS** 4

This window is active. You can click on the speaker or on the speaker system to manage each single channel that, once selected, will be highlighted. If you keep the CTRL key pressed and click on another channel, this other channel will be selected and highlighted as well.

**LISTENING POSITION VISUAL INDICATOR**

This window includes the position indicator (highlighted in green). Four positions are pre-set: driver, passenger, front central (passenger driver) and rear central. The indication acts only and exclusively as reference, allowing to view the listening point optimized with the digital delay automated calculation. If delays are set according to the "driver" position and then you want to optimize the system also for the "passenger" position, you need to set the distances again through the specific menu, as the system does not update them automatically. If used together with the pre-sets, it is useful to create different setups according to the different listening positions.

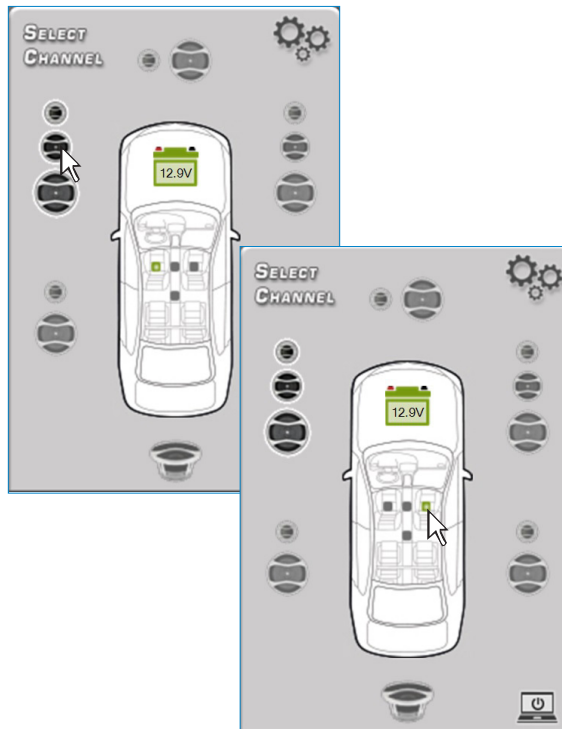

**VISUAL POWER SUPPLY INDICATOR**

This window contains the battery power level indicator of your car. This function is essential and informs the user, during the tuning phase of the bit One HD Virtuoso, about the real time power supply. The voltage display is numeric and takes on different colors depending on the voltage measured.

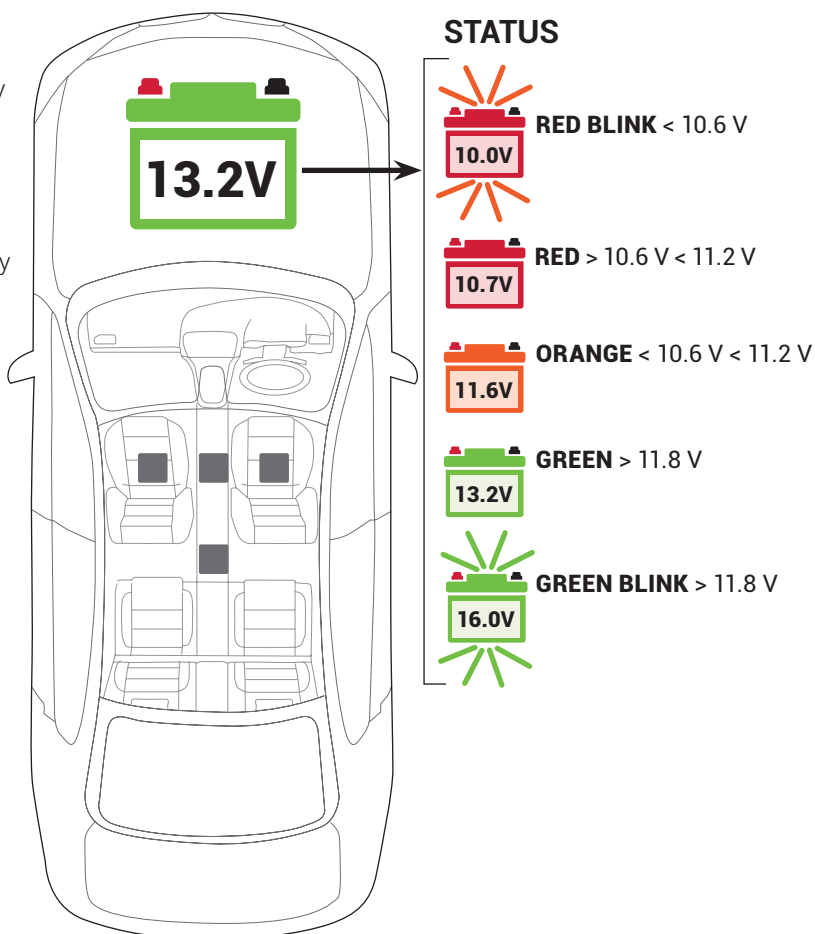

**FUNCTION**



[\(see section 8.3.3\)](#)



[\(see section 8.3.11\)](#)

**8.6 CHANNEL MAP**

**5**

This window displays the names given to the eight output channels of the bit One HD Virtuoso. This window is active. You can click on it to manage each channel which, once selected, will be highlighted. The software will anyhow only allow you to work on one single channel and will display the word **EDIT** in red next to the channel you can operate on. This selection ensures that all highlighted channels responses are displayed (see section 8.5).



**Remark:** the channels highlighted in green are dedicated to the AD Link 1 and AD Link 2 digital outputs.

**- Multi Sel:** Output channels multiple selection.

If you keep the CTRL key pressed and click on another channel, this other channel will be selected and highlighted as well. Multiple channels can be selected by ticking the "Multi Sel" box. Multiple selection is only allowed for functional groups, except for the Subwoofer that can be selected with any group.

To act on another channel keeping your selection, click on the right hand of the desired channel, where the EDIT column is.



**Selection View:**

**- EQ Settings:** if the "Link L / R" function is enabled, the pair of L/R channels of the selected outputs will be highlighted and the changes on the Channel EQ will be performed on both channels. If the "Link L / R" function is not active, only the chosen speaker will be selected and the changes will be active only on that one.

**- Filter Settings:** if the "Xover L / R Link" function is activated, the pair of L/R channels of the selected outputs will be highlighted and the changes on the Filter Settings will be performed on both channels. If the "Xover L / R Link" function is not active, only the chosen speaker will be selected and the changes will be active only on that one.

**Eg.:** Front Left Tweeter + Front Left Midrange + Front Left Woofer, but not together with Rear Left Full or Center Full. If you want to check the electrical response of the Rear system together with the Subwoofer, you need to deselect the Front system.

When multiple channels are selected, the display will show the electrical response of all channels with a blue curve, highlighting the "active" channel with the red color and the other channels selected in grey. The selection of a channel can also take place as shown in the diagram in the figure of paragraph 8.5.

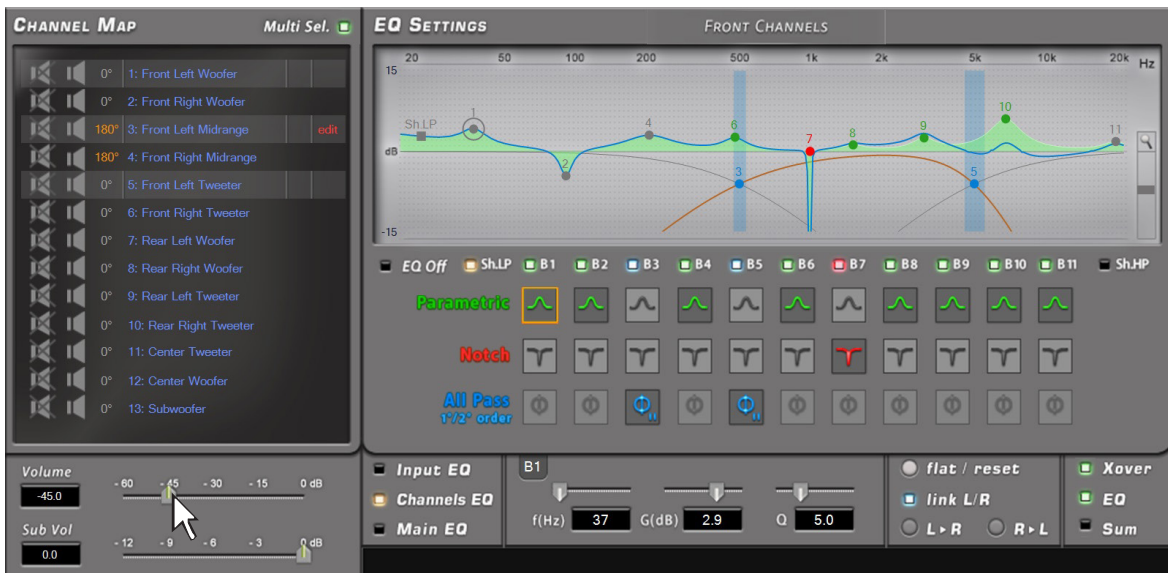

**8.7 FILTER SETTINGS / DELAY** 6

The bit One HD Virtuoso manages 13 crossovers, one for each output channel. Each filter allows the setting of the parameters related to the channel highlighted on the Channel Map. The filters can be adjusted in normal or extended mode through an active POP UP for a more detailed adjustment, activating it using the button.

**Remark:** by activating the PASS THROUGH mode the Filter Settings menu will not be active.



**8.7.1 FILTER SETTINGS**

By clicking on the icon, the menu for the output channels filter settings will appear as per image to the side.

**1. Xover L/R Link:** when activated, the modifications applied to one of the channels (right or left) will automatically be applied also to the other one. To activate it click on the blue flashing light.

**2. Invert Phase:** it provides the ability to invert the phase of the channel under examination by 180°. It can be activated by selecting the green flashing light. This function can be useful to solve alignment problems among the different filtered channels

**3. Filter Type:** it enables the selection of the different types of filters that can be assigned to the channels.  
**Full Range**  
**Low Pass**  
**High Pass**  
**Band Pass**

**WARNING:** in this case pay utmost attention to the filter adjustment. Speakers have mechanical limits which must not be exceeded and could lead to damage to the components.

**4. Filter Model:** it enables the selection of the applicable type of filter  
**Butterworth** (IIR)  
**Linkwitz** (IIR)  
**Bessel** (IIR)  
**FIR** (to be enabled during the Wizard [see sec. 7.2.2](#))

When starting the software, the bit One HD Virtuoso offers the Butterworth as a standard filter model. By changing the model to Linkwitz or Bessel, the change will be made only to the channel (mono) or channels (stereo - Xover Link activated) concerned.

If a FIR type system configuration was set up, the PC software will not allow to manage other types of filters. If you wish to switch to the Butterworth / Linkwitz or Bessel, (IIR) filters, proceed by converting the configuration file as suggested in [sec. 8.2.1](#).

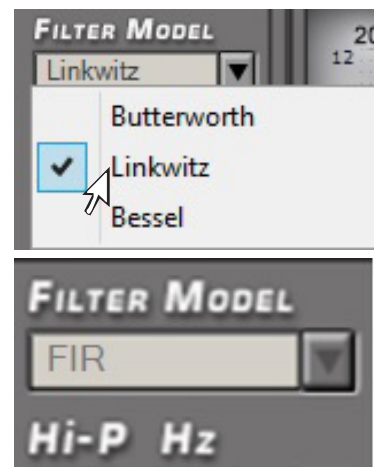
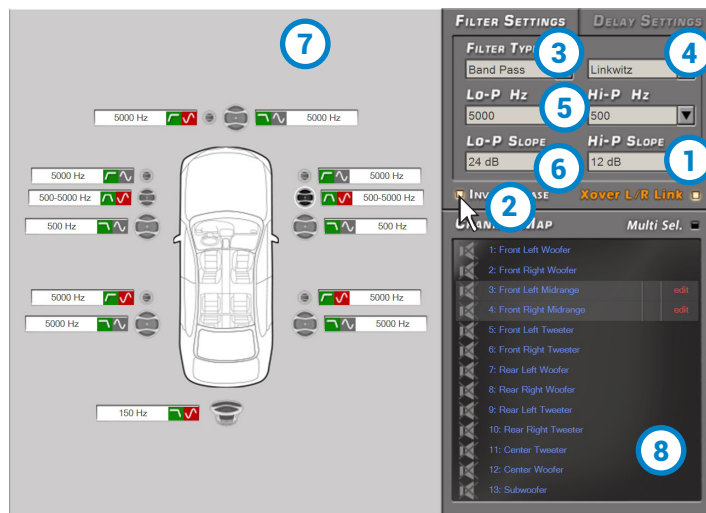

**Difference between IIR and FIR filters.**

IIR digital filters faithfully simulate analog filters (active or passive), approximating phase and frequency behavior. Like their analog equivalents, they are affected by unavoidable phase rotations at the cut-off frequency, which are different based on the type of curve used (Butterworth, Linkwitz, Bessel), however still perceived when listening.

In practice, for instance, a fourth-order low-pass IIR filter (24 dB / Oct) at 200 Hz cut-off, plus a high-pass symmetric filter, results in a phase rotation ranging from 0 to -360 degrees along the whole audio spectrum. This phase alteration affects the perception of the sound image, which highlights inaccuracies in terms of coherence and stability.

Think of a 3-way system where the door-mounted 18 cm woofer is 400 Hz crossed with the middle-range, installed on the a-pillar next to a tweeter, itself crossed with the middle-range at 5.000 Hz, using crossovers with IIR filters.

The system phase alteration reduces the focus of the instruments on the virtual stage. For this reason, a number of audio enthusiasts prefer to adopt 2-way systems with a woofer and tweeter crossing at 2.500 Hz with a slope of 6 dB / Oct, so as to limit phase rotations as much as possible. This solution, however, presents a number of significant disadvantages, mainly due to increased distortion and lower tweeter power. With a slope of only 6 dB / Oct., the music signal around the cut-off frequency is simultaneously generated by tweeters and woofers to a considerable extent. Since a tweeter and a woofer have very different electro-acoustic parameters, the sum of the two emissions does not produce clear output signals, which results in less clarity in the reproduction of musical transients.

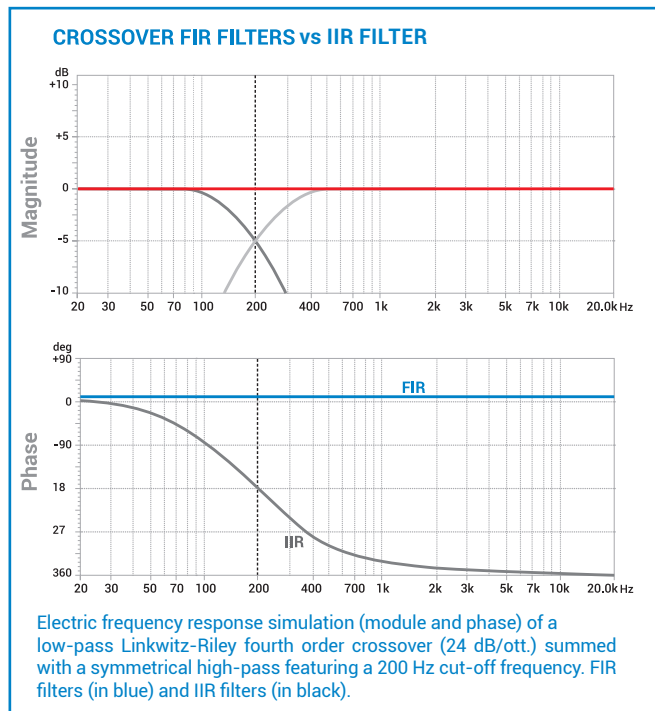

**Improved acoustic quality with the use of crossover filters and FIR equalizers.**

The use of FIR filters guarantees an important result: the phase behaviour is linear, free from rotations or indecisions. This also makes the use of filters with a very high slope (up to 48 dB / Oct) possible, without altering the phase response. Such a high slope for the filter enables the midrange and tweeters mounted on the a-pillar to work at lower frequencies without any issues with power handling, thus raising the emission front. Therefore thanks to the FIR filters the advantages of three or multiple-way systems are completely exploited taking in-car listening experience to a different level. When listening, a system that uses FIR filters provides great clarity in transients reproduction, such as the acoustic piano hammer strikes or the drums. The stereophonic image is deeper and definite. Instruments in the virtual stage are more focused and seem to have more space between them. Even the intervention of any equalizer over the frequency response, when available in FIR technology, does not modify the audio signal phase, allowing more precise and detailed corrections without conditioning the audio quality.

**5. Cut-off frequencies:**

- **Hi-P Hz**      10 ÷ 20000: filtro High-Pass
- **Lo-P Hz**      10 ÷ 44000: filtro Low-Pass

The cut-off frequency can be selected by:

- clicking on the corresponding drop-down menu, selecting the frequency range and the value;
- clicking on the corresponding drop-down menu, then moving from value to value with the arrows controls (up / down) on the PC keyboard;
- clicking on the corresponding drop-down menu and then moving from value to value with the use of a mouse featuring a rotating finger wheel
- Click on the cut-off frequency (Lo-P, Hi-P) section and edit the required value through the keyboard.

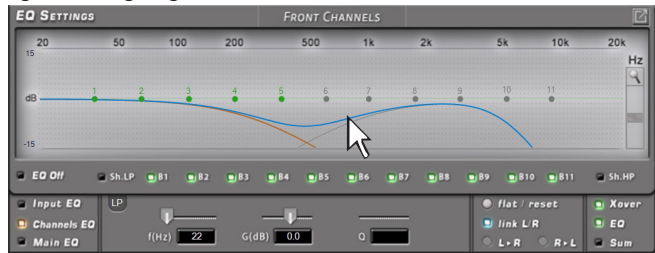
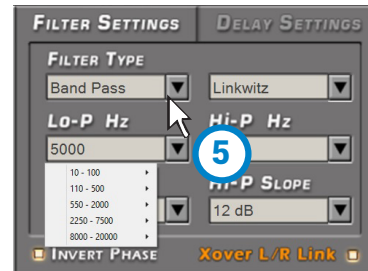

crossover frequency example:

**WARNING:** in this case, pay due attention to the filter adjustment. The speakers have mechanical limits that should not be exceeded and that could lead to their breakdown.

- |                   |                     |
|-------------------|---------------------|
| <b>Woofers</b>    | <b>Midrange:</b>    |
| - Low Pass 250 Hz | - Low Pass 900 Hz   |
|                   | - High Pass 5000 Hz |

**6. Filter slope**

- **Hi-P Slope**  
6/12/18/24/30/36/42/48 dB/Oct. (**Butterworth**)  
12/24/36/48 dB/Oct. (**Linkwitz**)  
6/12/18/24/30/36/ dB/Oct. (**Bessel**)
- **Lo-P Slope**  
6/12/18/24/30/36/42/48 dB/Oct. (**Butterworth**)  
12/24/36/48 dB/Oct. (**Linkwitz**)  
6/12/18/24/30/36/ dB/Oct. (**Bessel**)

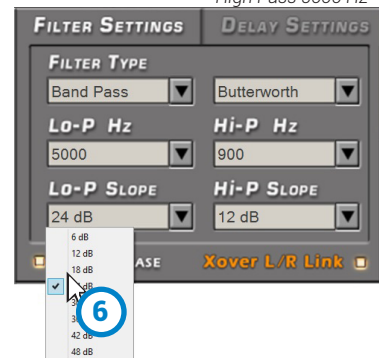

When starting up the software, the bit One HD Virtuoso offers

**Butterworth** with 12 dB/oct slope as default slope. By changing the slope, the change will be applied only to the channel you are working on.

**Eq.:** if you are adjusting the Front Woofer, the change will affect only that channel (right and left, if linked). If you selected Band Pass as filter type, the slope will be applied to both hi-pass and low-pass. With the Band Pass filter type the filter slopes can be unbound.



Crossover frequency 80 - 2000 Hz @ 12 dB/Oct.

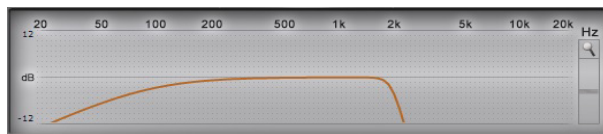

Crossover frequency 80 Hz @ 6 dB Oct. Hi-pass  
2000 Hz @ 48dB Oct. Low-pass

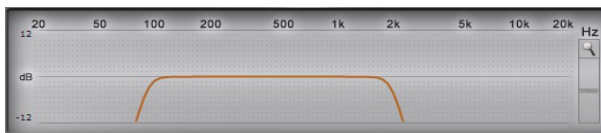

Crossover frequency 80 - 2000 Hz @ 48dB/Oct.



Crossover frequency 80 - 2000 Hz @ 48 dB/Oct. Hi-pass  
2000 Hz @ 6dB Oct. Low-pass

**7. Channel Map Filter settings**

This window shows the filters, cut-off frequencies and phase customization of each single component of the audio system. It is possible to change the parameters by first selecting the loudspeaker with the mouse, then setting the parameters as described in the points **1. 2. 3. 4. 5. 6.**

**8. Channel map**

This window shows the channels that make up the system and if the L / R link is active. Through the Mute button, it is possible to exclude one or more speakers present in the system during the calibration.

**Pass-through Mode Filter Setting**

In the case of Pass-Through mode with selection of the Master input, the cut-off frequencies of the channel bandwidth will not be editable, and by default will be set using the ones detected by the "Input Dashboard" analysis.

### 8.7.2 SET DISTANCE AND DELAY

Two modes are available for the set up of the bit One HD's time delays:

- **Basic Mode.** The system time delays can be displayed by selecting the Channel Map loudspeaker from the main software screen. Then enter the distances (cm/inch) from the listening point, and the related "fine set" (ms).

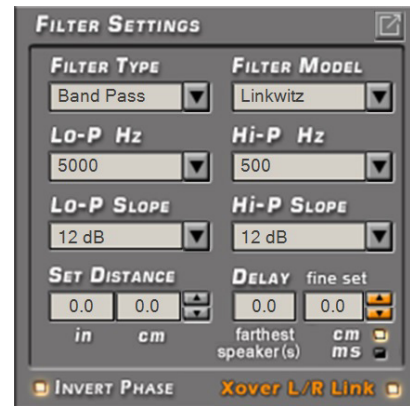



Fig.1

- **Extended Pop Up Mode,** by selecting the icon  the extended menu for the set up of time delays will appear. This operating mode, as well as allowing a faster and easier data entry, will provide different views of the time delays according to the listening point, the farthest speaker, depending on the distance (cm/inch) or time (ms).

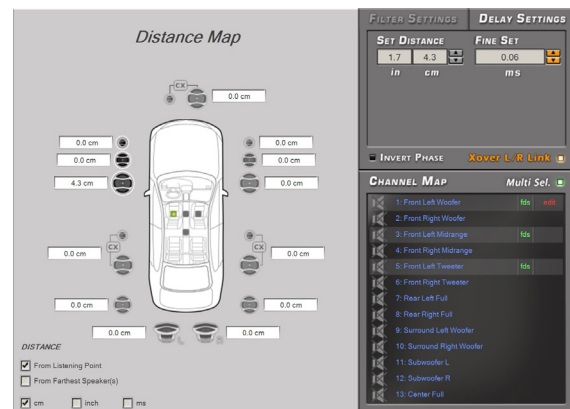

Fig.2

#### Preliminary remarks

Sound moves through the air at a speed of 343 mt/sec (1.125 ft/sec) and at the temperature of 20°C (68°F).

If you know the distance from the sound emission point, you can then calculate the time sound takes to get to the listener's ear. By default the bit One HD enables the entry/automatic calculation of time delays by entering the simple measurements between the listening point and the speakers by selecting the option "From Listening Point **cm/inch**". It is however possible to enter the same time delays with respect to the listening point by entering the time value (ms-milliseconds), selecting the option "From Listening Point **ms**".

If instead of the distance from the emission point only the distance between the loudspeakers with respect to the farthest emission point is available, it is possible, by selecting the option "From Farthest Speaker **cm/inch**, once the farthest speaker is selected, to enter distances from the other speakers, and then fine-tune the remaining speakers of the system. However, it is possible to enter the same time delays with respect to the farthest speaker by entering the time value (ms-milliseconds), selecting the option "From Farthest Speakers **ms**".

Switching between the 4 time delay entry modes is automatic, the software will automatically convert the values displayed on the Channel Map.

#### FINE SET AND PHASE DELAY.

The delay assignment according to the distance calculation is theoretical. That is, small variations need to be applied due to small errors in distance measurement, due to the resonance inside the car compartment and, mainly, due to the speaker phase problem. Two speakers reproducing two areas of frequency one close to the other (ex. Woofer and Midrange), in their crossing area will simultaneously reproduce, at attenuated level, the same frequencies. Due to the different nature of the speakers, they will show a difference in phase that, for a short frequency interval, works like a time delay.

By acting on the "fine set" you can partly also correct problems of Phase Delay.

By acting on the "fine set" you can change the automatically set time delay. The delay that is varied adds up to (+ x.xx) or is deducted from (- x.xx) the value of the delay shown in the "Delay / default" window, which does not change the assigned value which is the one automatically assigned. Assigning a positive value (+ x.xx) with the "fine delay" means increasing the delay of that speaker and therefore moving it away from the listening point. Likewise, assigning a negative value (- x.xx) means decreasing the speaker's delay and therefore moving it closer to the listening point. If you try and give a negative value to the farthest speaker, an alert message will be displayed. By acting on "fine set", the word "fds" will light up on the corresponding channel of the "Channel Map", to inform the user about the entry on the highlighted channels.

### 8.7.2.1 TIME DELAYS ENTRY BASIC MODE

Switching from POP UP mode to the PC software normal display mode will only show the standard display of the menu described below.

By selecting a channel from the Channel Map, it will be possible to act on the parameters:

- **Set Distance:** to edit the selected loudspeaker distance (cm/inc) from the Channel Map.
- **Fine Set (ms).**
- **Delay Default from Farthest Speakers.**

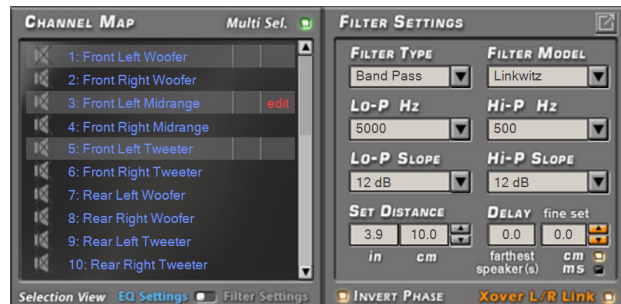

1. choose the system listening point. To identify the listening point, choose an ideal point located at the center of the listener's (driver or passenger) head. For the front central and rear central points choose an intermediate point between the two listeners.

2. measure the distance between each loudspeaker or group of loudspeakers and the listening point in a straight line ("as the crow flies"). For each loudspeaker choose the center of the mobile membrane as the emission point. For the groups of loudspeakers choose an intermediate point between them. Afterwards, fine-tuning can be performed by selecting the Fine Set function.

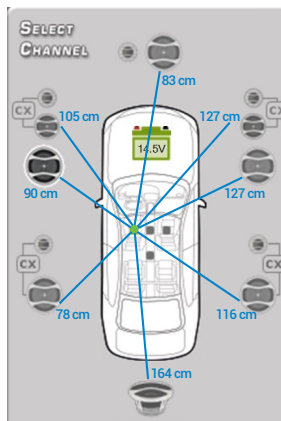

3. select the channel related to the loudspeaker under exam from the Channel Map and enter the related distance value on the Set Distance box from the Filter Settings menu.

4. repeat step 3 for each channel

5. perform all the time delays settings, start the music reproduction and select the Fine Set box. If you move the values to positive or negative (except for the subwoofer as it is the farthest speaker), you can find the best time alignment that will ensure a correct acoustic scene. The fine set tuning can be managed through the multiple selection of the audio system emission front (i.e. Front Left Tweeter + Front Left Midrange + Front Left Woofer). Select the front (Left or Right) channels keeping the CTRL key pressed with the mouse pointer, then proceed to the fine set tuning.

It is advisable to listen to different types of musical tracks (percussions, melodic etc.) for a much more correct evaluation of the different musical instruments coherency (space stability).

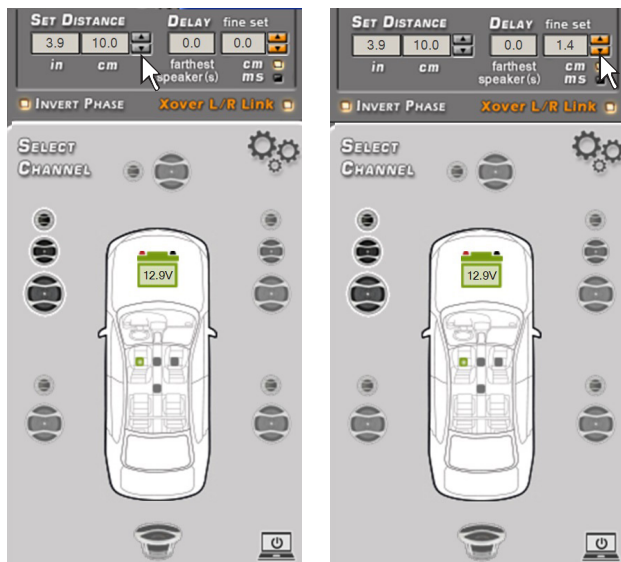

**WARNING:** if, once you have set the distances according to the "driver" listening point you click on the "passenger" listening point, the bit One HD will not re-calculate the delays according to the new reference point because the buttons available in the SELECT A CHANNEL diagram are merely descriptive and their only purpose is to remind you that you have set the delays for that listening point!

### 8.7.2.2 TIME DELAYS ENTRY POP UP MODE

By selecting the icon , the customization menu of the output channel filters will appear as shown to the side. It will be possible to intervene to set the time delays by clicking on DELAY SETTINGS.

#### Time delays entry default mode "From listening Point cm/inch"

This setting is based on an automatic system that allows you to calculate the time it takes for the loudspeaker to reach the ear.

1. choose the system listening point. To identify the listening point, choose an ideal point located at the center of the listener's (driver or passenger) head. For the front central and rear central points choose an intermediate point between the two listeners.
2. measure the distance between each loudspeaker or group of loudspeakers and the listening point in a straight line ("as the crow flies"). For each loudspeaker choose the center of the mobile membrane as the emission point. For the groups of loudspeakers choose an intermediate point between them. Afterwards, fine-tuning can be performed by selecting the Fine Set function.
3. select the channel related to the loudspeaker under exam from the Channel Map and enter the related distance value on the Set Distance box from the Filter Settings menu.
4. repeat step 3 for each channel.
5. perform all the time delays settings, start the music reproduction and select the Fine Set box. If you move the values to positive or negative (except for the subwoofer as it is the farthest speaker), you can find the best time alignment that will ensure a correct acoustic scene. The fine set tuning can be managed through the multiple selection of the audio system emission front (I.e. Front Left Tweeter + Front Left Midrange + Front Left Woofer). Select the front (Left or Right) channels keeping the CTRL key pressed with the mouse pointer, then proceed to the fine set tuning. It is advisable to listen to different types of musical tracks (percussions, melodic etc.) for a much more correct evaluation of the different musical instruments coherency (space stability).

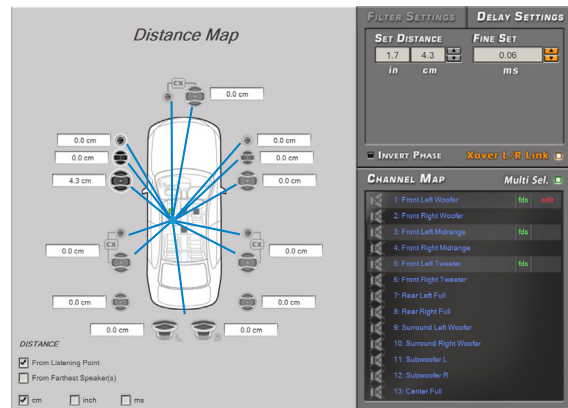

Once all the speaker distances have been entered, it is possible to obtain automatically by clicking on the check boxes:

- From Listening Point (ms): the related delay between the listening point and the system speakers. If a fine set is entered, the value on the Channel Map will become red.

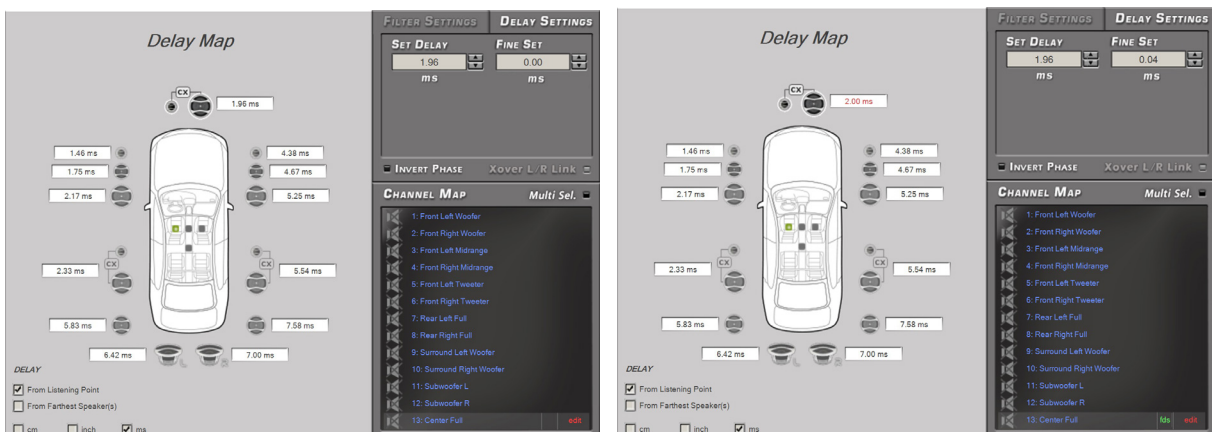

- From Farthest Speaker cm/inch: the related distance between the loudspeakers and the farthest speaker in the system.

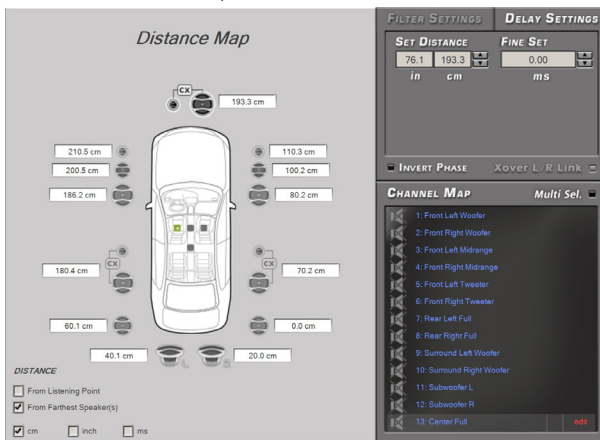

- From Farthest Speaker ms: the delay introduced between the farthest speaker and the rest of the system. If a fine set is entered, the value on the channel map will become red.

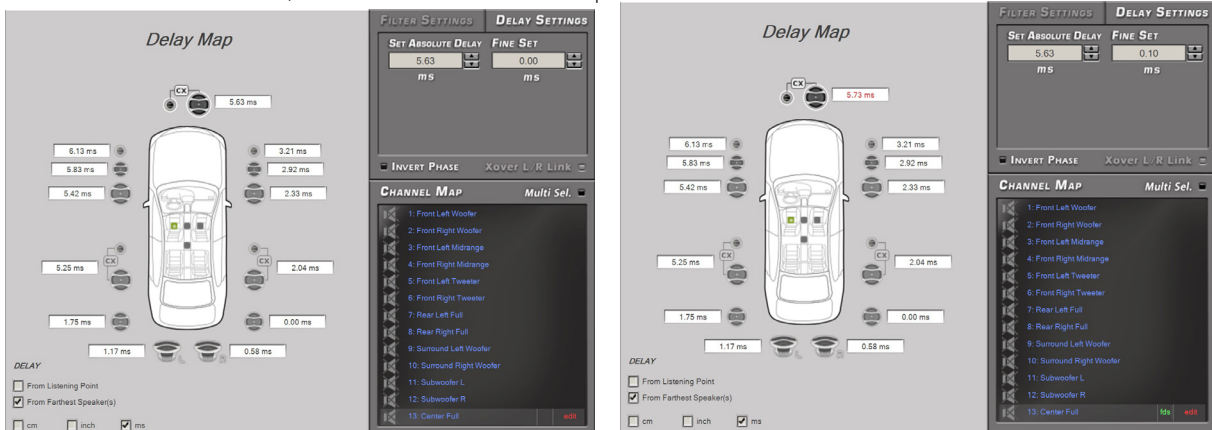

- The software, in addition to offering the conversion of values according to the selected mode, will allow their adjustment, passing from one mode to another.

**WARNING:** if, once you have set the distances according to the “driver” listening point you click on the “passenger” listening point, the bit One HD will not re-calculate the delays according to the new reference point because the buttons available in the SELECT A CHANNEL diagram are merely descriptive and their only purpose is to remind you that you have set the delays for that listening point!

### 8.7.2.3 TIME DELAY SETTING PASS-THROUGH MODE.

In the case of the Pass-Through mode with selection of the Master input, it is also possible to manage time delays. It must be specified that if the bit One HD is interfaced to a source with time delays, it is advisable to intervene by acting only on the Fine Set.

Once the time alignment procedure has been completed, it will be possible to intervene on the output equalizer (MASTER), to optimize the response of the system according to the level alignment at the various frequencies.

For the auxiliary inputs Optical 1/2 and Aux instead it is possible to act on the time delays setup, as described in the previous paragraphs, since these inputs are not connected to the Master input.

## 8.8 EQ SETTINGS

8

The **bit One HD Virtuoso** software provides a series of Parametric / Paragrafic equalizers to be managed on screen which, with extreme versatility, provide for an optimal calibration of the audio system. The user can operate on the equalization of the **Master** or **AUX** analog inputs by choosing the “**Input EQ**” option, on the single output channels equalization by selecting the “**Channels EQ**” option and operate on the whole system equalization by choosing the “**Main EQ**” option. Thanks to the active Pop Up menu it is possible to intervene in a more precise and accurate way on all the available intervention points, working full-screen on the equalizers using all the control commands.

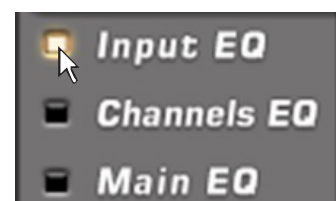

parametric-eq parametric eq mode

**8.8.1 Parametric/Graphic INPUT EQ**

Click the "Input EQ" box and the equalization curve for the bit One HD Virtuoso active input will be displayed. By clicking on the POP UP activation icon, you can bring to Full screen the display of the main controls of the equalizer. If you do not use the POP UP mode it will always be possible to perform system tuning but reducing the use of the equalizer functions.

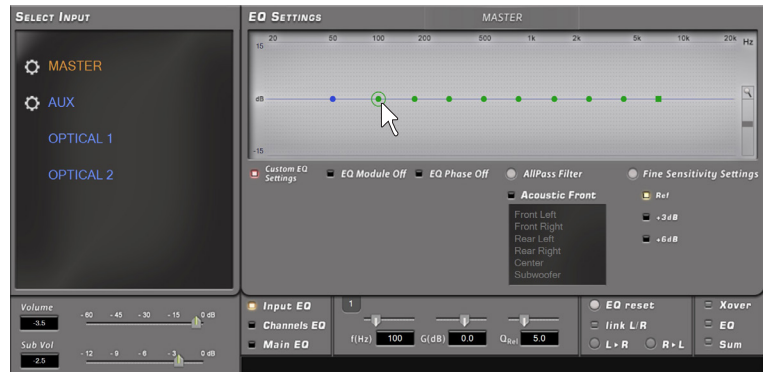

**MASTER INPUT SETTING**

It is possible to operate on the equalizer of the Master input, acting on all the fronts at the same time, or by activating the **Acoustic Front** option, on each single input front.

It is also possible to compensate for any phase rotations of the input fronts by activating the **AllPass Filter** menu, using 4 intervention points consisting of a second order All Pass.



**Parametric EQ adjustment**

**A. MODULE:** select MASTER on the graphic interface and then MODULE to modify the equalizer parameters, in order to set up a 10 pole (of which 9 FIR - blue poles) and 1 IIR (green pole) equalization curve. By operating on the setup window it is possible to adjust the **Frequency (f: 20 Hz ÷ 20KHz step min 1Hz)**, **Gain (g: -15 dB ÷ +12dB step min 0.1 dB)** and the **Q factor (Q: 0.1 ÷ 16 step min 0.1)** using the cursors.

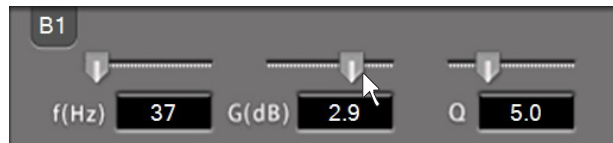

Example of IIR pole adjustment

The curve can be manually edited using the mouse pointer. To be able to vary the "F" "G" and "Q" factors, you will just need to act on the mouse wheel equipped with this function. A finer adjustment of these parameters can also be made using only the PC keyboard.



Example of FIR pole adjustment

- The keys and : allow the selection of the pole to be adjusted on the diagram. The successful selection of the pole is displayed by a circle around it.
- Key: allows the selection of the "F", "G" and "Q" poles control point. The successful selection of the control point is visible through the green color of the control slider.
- Keys and .

graphic-eq graphic EQ mode

**Graphic EQ adjustment**

**A. MODULE:** select MASTER in the graphic interface and then MODULE to change the equalizer parameters, in order to set a curve using a 31-band graphic equalizer. Using the setup window, it is possible to select the third octave frequency and the Gain (g: -15 dB ÷ + 12dB step min 0.1 dB) with a fixed quality factor Q (4.3).

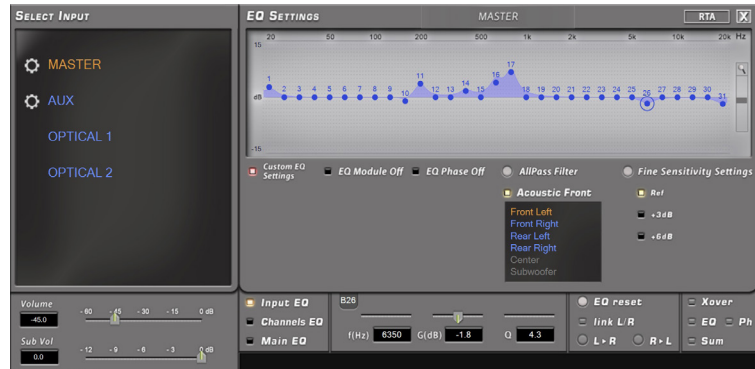

- Keys and : they allow the user to select the pole to be adjusted in the graph. The successful selection of the pole is displayed by a circle around it.
- Button : it allows you to select the gain of the pole. The successful selection of the control point is visible through the green color of the control slider.
- Keys and .



Example of IIR pole adjustment

**Activation:**



- Custom EQ Settings: by enabling the function (light on) it is possible to enable the changes made to the equalizer and the All Pass input filters.
- EQ Module Off: by enabling the function (light on) it is possible to disable the changes made to the input equalizer. This function is necessary during the calibration phase to appreciate and evaluate the settings selected.
- EQ Phase Off: by enabling the function (light on) it is possible to disable the changes made to the All Pass input filters. This function is necessary during the calibration phase to appreciate and evaluate the settings selected.

**B. All-Pass.** The graphic interface will show the fronts related to the application of the All-Pass filters (Front L-R, Rear L-R, Center), and a chart showing the electric result of the fronts selected from the menu. If a phase analysis was performed during the "Configuration Wizard" (see section 7.2.2.6), the compensation points recommended by the analysis will be displayed. They can be fine tuned thanks to the electrical result and listening sessions.

If the automatic phase analysis procedure has not been performed, the All-Pass control points will be present but no position for compensation will be recommended.

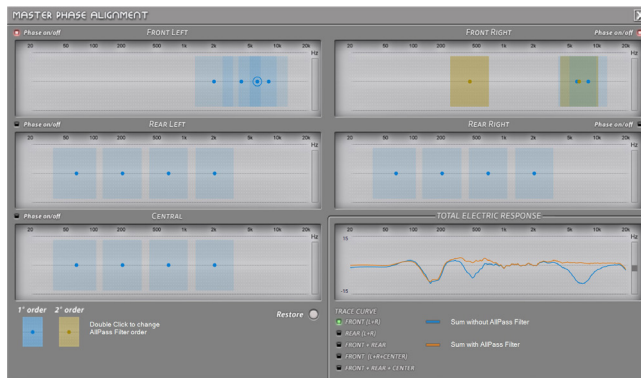

**All-Pass Filter type:**

There are two types of All-Pass filters, 1st and 2nd order. Their selection is done by double clicking with the mouse pointer, which will highlight the area with a different color depending on the type selected. First order filters are light blue, while second order filters are yellow. Their activation is displayed by the transition from a point to a well-highlighted intervention area that occurs by setting the phase other than 0°.



**All-Pass Filters Setting:**

**Frequency:** by moving the point to adjust with the mouse pointer (f: 20 Hz ÷ 20KHz)

**Phase:** **CTRL** + **←** e **CTRL** + **→** allows the change of the Phase control at 1 degree Steps. For 1st order All-Pass the adjustment ranges from 0-180° while for 2nd order All-Pass the adjustment ranges from 0 -360°.

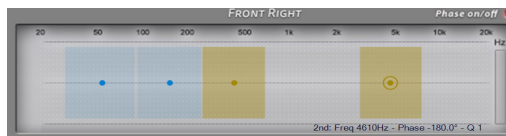

**Q:** **CTRL** + **↑** e **CTRL** + **↓** allows the change of the Q factor at 0.1 Steps (just for 2nd order All-Pass).

**Total Electric Response.**

The chart shows the electrical sum of the channels selected in the menu "Trace Curve". If a "Phase Analysis" was performed (see sec. 7.2.2.7), two curves will be displayed. The Blue curve refers to the trend of the selected fronts, where the presence of All-Pass filters can be shown, provided by one or more holes in the frequency domain, while the orange color refers to the fronts compensation via All-Pass filters. If the Phase Analysis was not performed, only the orange curve resulting from the modifications made via All-Pass adjustment will be displayed.

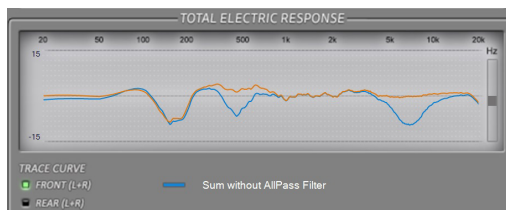

**Phase ON/OFF / Activate**

By clicking on the Phase on/off key, it is possible to enable or disable the correction of the phase applied to the Head Unit connected to the bit One HD Virtuoso. The activation is successful when the led light becomes red.



**Restore Phase Alignm suggestions:**

If an "AUTOMATIC MASTER DE-EQ / PHASE Analysis" was performed and new valued are then edited, it will be possible to restore the phase compensation values suggested by the software (see sec. 7.2.2.6).



- C. LEVELS:** during the tuning phase of the inputs it is possible to carry out a further refinement of the input levels. This can be done by selecting the Fine Settings item, which will allow you to act on the sliders of the input sensitivity of each Master channel (previously set automatically), or via the active buttons:
- +6dB:** increasing the sensitivity of all channels by 6dB, compared to automatic calibration.
  - +3dB:** increasing the sensitivity of all channels by 3dB, compared to automatic calibration.

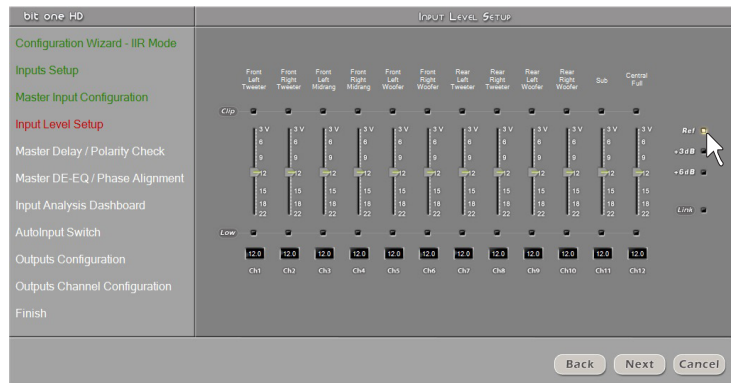

**Remark:** If you decided to use the RVA function, it is not advisable to use gain increases + 3dB / + 6dB, which could cause distortions when adjusting the volume of the auxiliary source (AUX / Optical).

**Ref:** setting the sensitivity of all channels to the level calculated in the automatic calibration.

### AUX INPUT SETTING

- A. Select AUX** on the graphic interface to modify the equalizer parameters, in order to set up a 10 pole (of which 9 FIR - blue poles) and 1 IIR (green pole) equalization curve. By operating on the setup window it is possible to adjust the *Frequency (f: 20 Hz ÷ 20kHz step min 1Hz)*, *Gain (g: -15 dB ÷ +15dB step min 0.1 dB)* and the *Q factor (Q: 0.1 ÷ 16 step min 0.1)* using the cursors.



The curve can be manually edited using the mouse pointer. To be able to vary the "F" "G" and "Q" factors, you will just need to act on the mouse wheel equipped with this function. A finer adjustment of these parameters can also be made using only the PC keyboard.

- The keys **←** and **→**: allow the selection of the pole to be adjusted on the diagram. The successful selection of the pole is displayed by a circle around it.
- **TAB** Key: allows the selection of the "F", "G" and "Q" poles control point. The successful selection of the control point is visible through the green color of the control slider.
- Keys **CTRL** + **←** and **CTRL** + **→**.

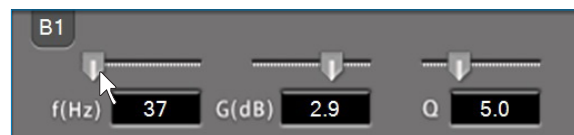

Example of IIR pole adjustment

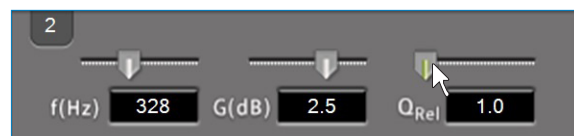

Example of FIR pole adjustment

- B. Levels:** during the tuning phase of the inputs it is possible to carry out a further refinement of the input levels.

This can be done by selecting the **Fine Settings** item, which will allow you to act on the sliders of the input sensitivity of each Master channel (previously set automatically), or via the active buttons.

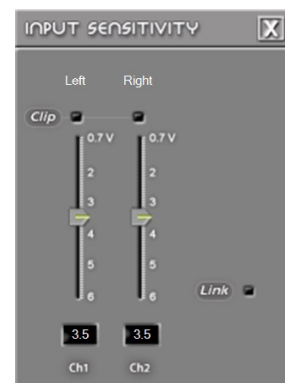

**OPTICAL 1 / OPTICAL 2 INPUT SETTING**

**A. Select Optical 1 / Optical 2**

on the graphic interface to modify the equalizer parameters, in order to set up a 10 pole (of which 9 FIR - blue poles) and 1 IIR (green pole) equalization curve. By operating on the setup window it is possible to adjust the **Frequency** ( $f$ : 20 Hz ÷ 20KHz step min 1Hz), **Gain** ( $g$ : -15 dB ÷ +15dB step min 0.1 dB) and the **Q factor** ( $Q$ : 0.1 ÷ 16 step min 0.1) using the cursors.

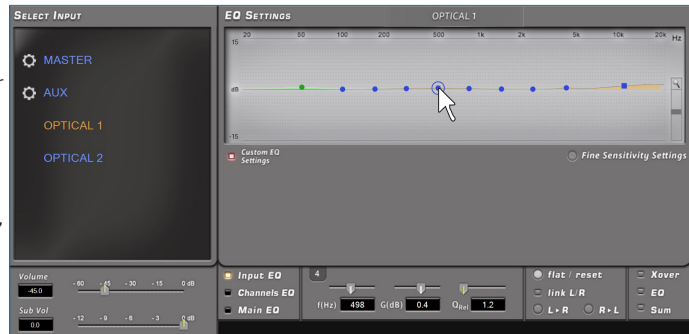

The curve can be manually edited using the mouse pointer. To be able to vary the "F" "G" and "Q" factors, you will just need to act on the mouse wheel equipped with this function. A finer adjustment of these parameters can also be made using only the PC keyboard.

- The keys and : allow the selection of the pole to be adjusted on the diagram. The successful selection of the pole is displayed by a circle around it.
- Key : allows the selection of the "F", "G" and "Q" poles control point. The successful selection of the control point is visible through the green color of the control slider.
- Keys + and + .

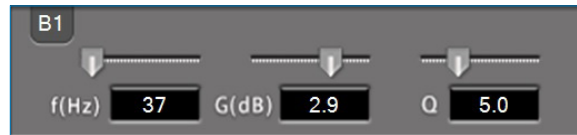

Example of IIR pole adjustment

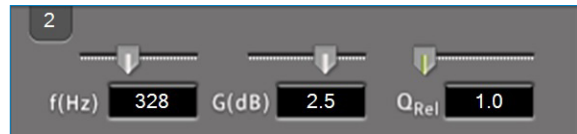

Example of FIR pole adjustment

### 8.8.2 CHANNELS AND FRONT EQUALIZER

The CHANNEL EQ equalizer works for functional groups and for each channel according to the selection chosen for the display. It is possible to perform an equalization by selecting a single speaker in the system or selecting the entire front of the audio system.

#### Difference between IIR and FIR filters

Similarly to crossover filters (*see sec 8.7.1*), graphic and parametric equalizers based on IIR filters alter the signal phase behaviour with significant effects on audio quality. A heavily equalized signal is characterized by an unclear stereo image and lack of transients definition. Audiophiles often classify this feeling as a veil that blurs the musical message and deprives it of the necessary emotion.

The use of FIR filters guarantees an important result: the phase behaviour is linear, free from rotations or indecisions. This also makes the use of filters with a very high slope (up to 48 dB / Oct) possible, without altering the phase response. Such a high slope for the filter enables the midrange and tweeters mounted on the a-pillar to work at lower frequencies without any issues with power handling, thus raising the emission front. Therefore thanks to the FIR filters the advantages of three or multiple-way systems are completely exploited taking in-car listening experience to a different level. When listening, a system that uses FIR filters provides great clarity in transients reproduction, such as the acoustic piano hammer strikes or the drums. The stereophonic image is deeper and definite. Instruments in the virtual stage are more focused and seem to have more space between them. Even the intervention of any equalizer over the frequency response, when available in FIR technology, does not modify the audio signal phase, allowing more precise and detailed corrections without conditioning the audio quality.

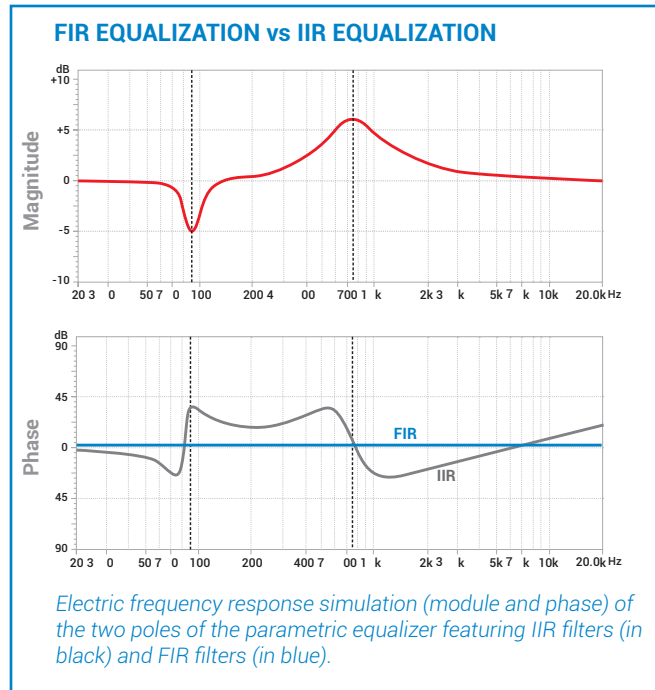

The equalizer works for functional groups and therefore we will have:

- an equalizer for the Front Left Channel;
- an equalizer for the Front Right Channel;
- an equalizer for the Rear Left Channel;
- an equalizer for the Rear Right Channel;
- an equalizer for the Center;
- an equalizer for the Subwoofer.

The software is able to manage both an IIR and FIR configuration chosen during the "I / O Configuration Wizard" phase, and the equalizer setup varies depending on the choice made.

### 8.8.2.1 IIR GRAPHIC EQ MODE

By clicking on the POP UP activation icon, you can bring the main equalizer commands to full screen. If you do not use the POP UP mode, it will always be possible to tune the system but by reducing the use of the equalizer functions. It is possible to calibrate the output of the edges using a 31-band graphic equalizer. To be able to change the equalizer parameters, in order to set a curve, just select the channel to be equalized from the "Channel Map" menu, and moving the gain of the pole/s on which to intervene. Use the mouse cursor or the menu below.



G(dB): it is possible to set the gain of the selected band by acting on the setup window and adjusting using the Gain (g: -15 dB ÷ + 12dB step min 0.1 dB.

The curve can be manually edited using the mouse pointer. To be able to vary the "F" "G" and "Q" factors, you will just need to act on the mouse wheel equipped with this function. A finer adjustment of these parameters can also be made using only the PC keyboard.

- The keys and : allow the selection of the pole to be adjusted on the diagram. The successful selection of the pole is displayed by a circle around it.
- Keys and .

The POP UP menu allows a 360 ° use of the main functions through the functions that can be activated via the Channel Map.

- 1) MUTE:** Mute Enabled; Mute disabled.
- 2) SOLO:** Solo Enabled; Solo disabled
- 3) PHASE:** Phase not inverted; Phase inverted.
- 4) Multi Sel:** it allows the activation of multiple channels on the Channel Map in order to display the total electrical response on Channels EQ.
- 5) Volume:** it manages the overall system volume.
- 6) Volume Sub:** it manages the overall SUB level volume.

During the equalizer calibration, the display shows the changes that are made to the electrical signal that is sent to the speakers via the amplifiers in real time.

The actual audio signal reproduced by the system depends on the type of speakers used and their positioning. To analyse the acoustic response, use a spectrum analyser connected to a microphone. Otherwise you need to make use of your experience in listening and refine the calibration by relying on it.



- 1. Flat / Reset:** it restores, if enabled, all the poles of the parametric equalizer in the default position.
- 2. Link L/R:** it applies, when active, the equalization curve to both the right and left channels simultaneously.
- 3. L->R R->L:** this function is active when "Link L / R" is deactivated. By clicking on one of the two keys it is possible to transfer the equalization curve of the Left channel to the Right one and vice versa.
- 4. Xover:** it displays the electrical response subjected to filtering (XOVER), by clicking on the box (red curve).



- 5. EQ:** it displays the electrical response subjected to equalization, by clicking on the box (yellow curve).
- 6. SUM:** it displays the sum between the electric response and the crossover, by clicking on the box (purple curve).
- 7. PH:** It allows the user to view the progress of the electrical phase. Its performance depends on the filters and the equalization applied.

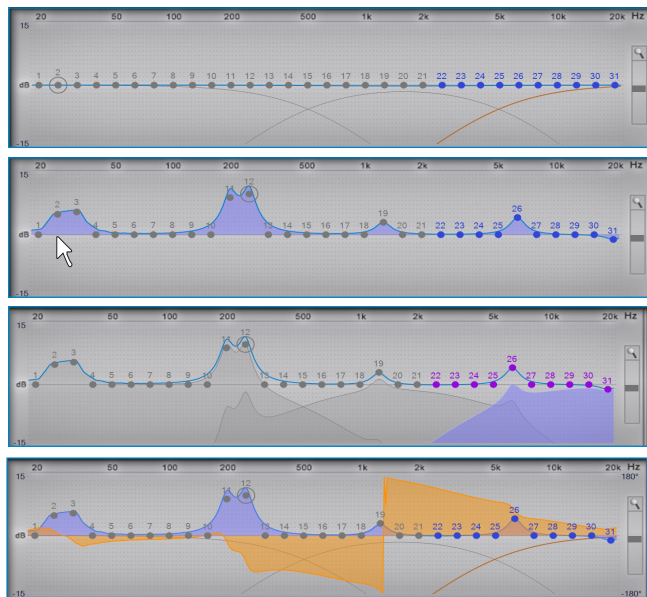

- 8. EQ Off:** when active, it allows the equalizer to be switched off.

### 8.8.2.1 IIR PARAMETRIC EQ MODE

By clicking on the POP UP activation icon , you can bring to Full screen the display of the main controls of the equalizer. If you do not use the POP UP mode it will always be possible to perform system tuning but reducing the use of the equalizer functions.

It is possible to calibrate the fronts output using a 13-pole equalizer of which 11 maximum parametric poles and two shelving (LP HP). Furthermore it is possible to activate up to three Notch and ALLPASS filters according to the crossover frequencies.

To be able to change the equalizer parameters, in order to set an equalization curve, just select the channel to be equalized from the "Channel Map" menu, enable the pole on which to intervene with the mouse cursor and set the configuration to be applied. The following controls are available on the front equalization curve:

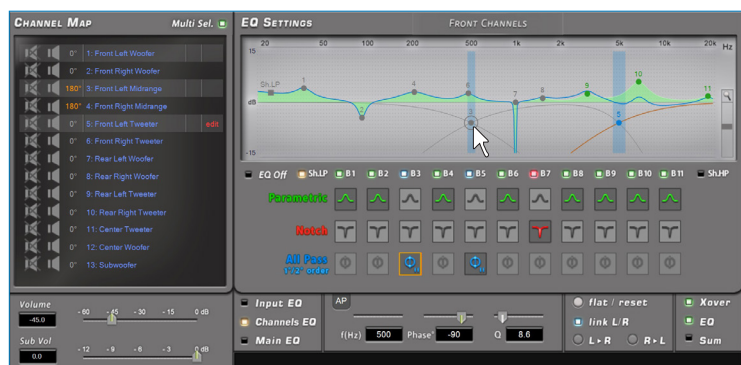

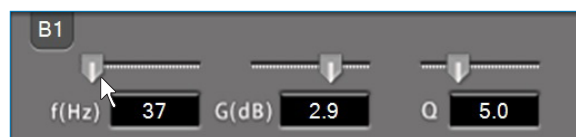

- A. Parametric pole:** it is possible to set the parametric pole by operating on the setup window adjusting the **Frequency** ( $f$ : 20 Hz ÷ 20KHz step min 1Hz), **Gain** ( $g$ : -15 dB ÷ +12dB step min 0.1 dB) and the **Q factor** ( $Q$ : 0.1 ÷ 16 step min 0.1) using the cursors.



- B. Notch filter:** it is possible to set the Notch filter by operating on the setup window adjusting the **Frequency** ( $f$ : 20 Hz ÷ 20KHz step min 1Hz), and the **Bandwidth** ( $BW$ : 20 Hz ÷ 5KHz step min 1Hz) using the cursors.



**C.**   **All Pass 1°/2° order:** the All Pass filter can be first-order by clicking once on the icon and second-order by double-clicking. This is automatically positioned on the crossover frequency of the first crossover, and the number of ALL PASS is equal to the crossing points on the fronts. Its function is to re-balance the speakers at their intersection point.

Their activation is displayed by the transition from a point to a well-highlighted intervention area that occurs by setting the phase other than 0°

- **First-order filter:** it is possible to set the All Pass filter by operating on the setup window adjusting the *Phase (Phase: 0°÷ -180° step min 1°) using the cursors.*

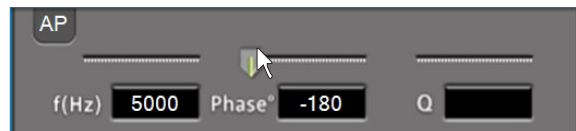



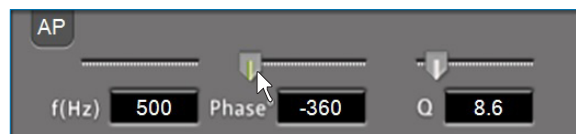

- **Second-order filter:** it is possible to set the All Pass filter by operating on the setup window adjusting the *Phase (Phase: 0°÷ -360° step min 1°) and the Q factor (Q: 0.4÷50) using the cursors.*

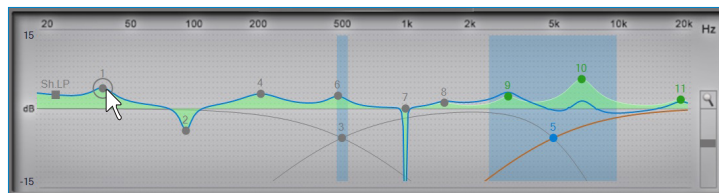







In the case of the two types of All Pass filters, the intervention will be graphically highlighted on the equalizer curve, using a light blue area.



The curve can be manually edited using the mouse pointer. To be able to vary the "F" "G" and "Q" factors, you will just need to act on the mouse wheel equipped with this function. A finer adjustment of these parameters can also be made using only the PC keyboard

- The keys  and : allow the selection of the pole to be adjusted on the diagram. The successful selection of the pole is displayed by a circle around it
- Key : allows the selection of the "F", "G" and "Q" poles control point. The successful selection of the control point is visible through the green color of the control slider.
- Keys  and .

The POP UP menu allows a 360° use of the main functions through the functions that can be activated via the Channel Map.

- 1) **MUTE:**  Mute Enabled;  Mute disabled.
- 2) **SOLO:**  Solo Enabled;  Solo disabled
- 3) **PHASE:**  0° Phase not inverted;  180° Phase inverted.
- 4) **Multi Sel:** it allows the activation of multiple channels on the Channel Map in order to display the total electrical response on Channels EQ.
- 5) **Volume:** it manages the overall system volume.
- 6) **Volume Sub:** it manages the overall SUB level volume.

During the equalizer calibration, the display shows the changes that are made to the electrical signal that is sent to the speakers via the amplifiers in real time.

The actual audio signal reproduced by the system depends on the type of speakers used and their positioning. To analyse the acoustic response, use a spectrum analyser connected to a microphone. Otherwise you need to make use of your experience in listening and refine the calibration by relying on it.



1. **Flat / Reset:** it restores, if enabled, all the poles of the parametric equalizer in the default position.
2. **Link L/R:** it applies, when active, the equalization curve to both the right and left channels simultaneously.
3. **L->R R->L:** this function is active when "Link L / R" is deactivated. By clicking on one of the two keys it is possible to transfer the equalization curve of the Left channel to the Right one and vice versa.
4. **Xover:** it displays the electrical response subjected to filtering (XOVER), by clicking on the box (red curve).



5. **EQ:** it displays the electrical response subjected to equalization, by clicking on the box (yellow curve).
6. **SUM:** it displays the sum between the electric response and the crossover, by clicking on the box (purple curve).
7. **PH:** It allows the user to view the progress of the electrical phase. Its performance depends on the filters and the equalization applied.
8. **EQ Off:** when active, it allows the equalizer to be switched off.

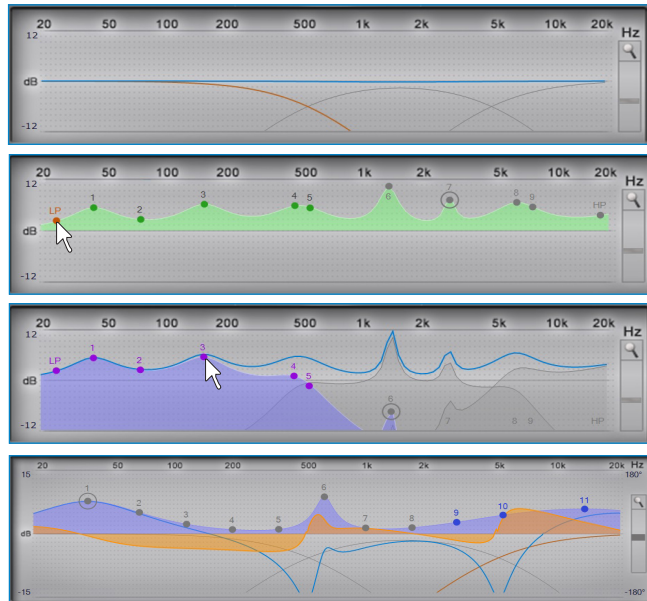

**Remark:** in order to display the set equalization curve more clearly, it is possible to increase or decrease the vertical scale (dB) by moving the cursor positioned to the right of the equalization curve diagram. By default the diagram display is set to  $\pm 12$ dB.



View example with  $\pm 3$ dB magnifier function



View example with  $\pm 24$ dB magnifier function

### 8.8.2.3 FIR MODE



By clicking on the POP UP activation icon , you can bring to Full screen the display of the main controls of the equalizer. If you do not use the POP UP mode it will always be possible to perform system tuning but reducing the use of the equalizer functions.

It is possible to calibrate the fronts output using a 13-pole equalizer of which 9 FIR poles, 1 Shelving and 3 IIR poles. Furthermore it is possible to activate up to three Notch and ALL PASS filters according to the crossover frequencies.

To be able to change the equalizer parameters, in order to set an equalization curve, just select the channel to be equalized from the "Channel Map" menu, enable the pole on which to intervene with the mouse cursor and set the configuration to be applied.

The following controls are available on the front equalization curve:

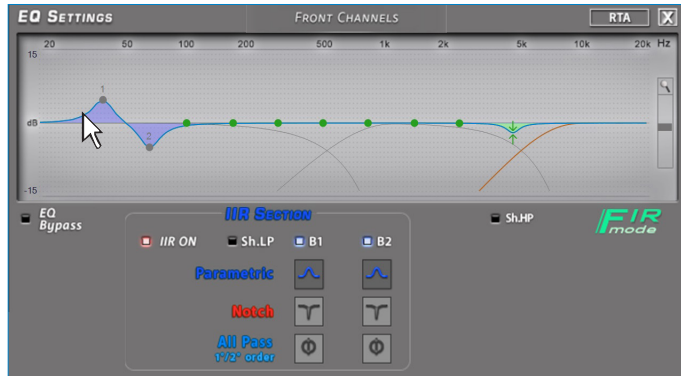

- **IIR POLES:** by enabling the check from PC software it is possible to enable the use of 3 IIR poles.

**A. Parametric pole:** it is possible to set the parametric pole by operating on the setup window adjusting the *Frequency (f: 500 Hz ÷ 20KHz step min 1HZ)*, *Gain (g: -15 dB ÷ +15dB step min 0.1 dB)* and the *Q factor (Q: 0.1 ÷ 16 step min 0.1)* using the cursors.

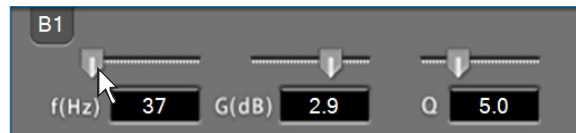

**B. Notch filter:** it is possible to set the Notch filter by operating on the setup window adjusting the *Frequency (f: 500 Hz ÷ 20KHz step min 1HZ)*, and the *bandwidth (BW: 20 Hz ÷ 5KHz step min 1HZ)*.



**C. All Pass 1°/2° order:** the **All Pass filter** can be first-order by clicking once on the icon and second-order by double-clicking. This is automatically positioned on the crossover frequency of the first crossover, and the number of **ALL PASS** is equal to the crossing points on the fronts. Its function is to re-balance the speakers at their intersection point.

- **First-order filter:** it is possible to set the All Pass filter by operating on the setup window adjusting the *Phase (Phase: 0° ÷ -180° step min 1°)* using the cursors.



- **Second-order filter:** it is possible to set the All Pass filter by operating on the setup window adjusting the *Phase (Phase: 0° ÷ -360° step min 1°)* and the *Q factor (Q: 0.4 ÷ 50)* using the cursors.

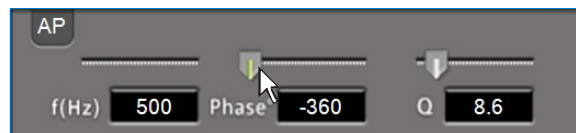

In the case of the two types of All Pass filters, the intervention will be graphically highlighted on the equalizer curve, using a light blue area.

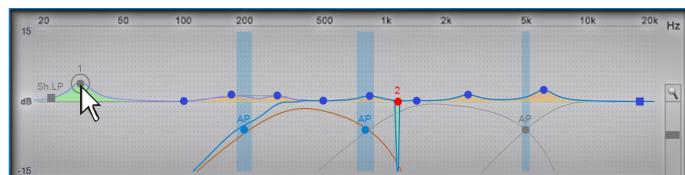

- **FIR POLES:** it is possible to set the FIR parametric pole by operating on the setup window adjusting the *Frequency (f: 100Hz÷20KHz step min 1HZ)*, *Gain (g: -15 dB ÷ +15dB step min 0.1 dB)* and the *Q factor (Q: 0.1÷ 16 step min 0.1)* using the cursors.

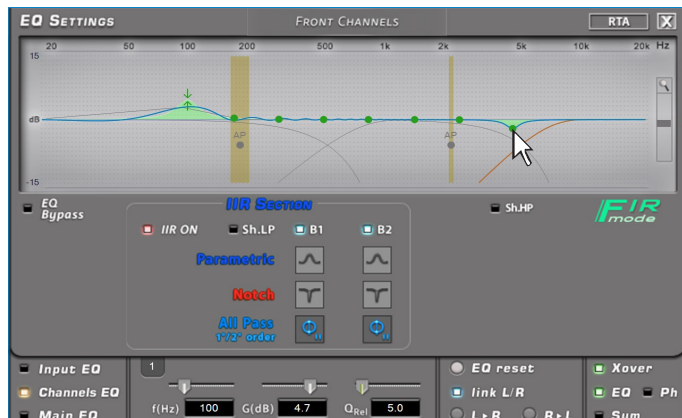

The poles can be edited manually using the mouse pointer. To change the "Q" factor, you will just need to act on the mouse wheel equipped with this function.

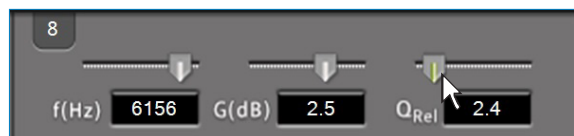

- The keys and : allow the selection of the pole to be adjusted on the diagram. The successful selection of the pole is displayed by a circle around it.
- Key : allows the selection of the "F", "G" and "Q" poles control point. The successful selection of the control point is visible through the green color of the control slider.
- Keys and .

The POP UP menu allows a 360 ° use of the main functions through the functions that can be activated via the Channel Map.

- 1) MUTE:** Mute Enabled; Mute disabled.
- 2) SOLO:** Solo Enabled; Solo disabled.
- 3) FASE:** Phase not inverted; Phase inverted.
- 4) Multi Sel:** it allows the activation of multiple channels on the Channel Map in order to display the total electrical response on Channels EQ.
- 5) Volume:** it manages the overall system volume.
- 6) Volume Sub:** it manages the overall SUB level volume.

During the equalizer calibration, the display shows the changes that are made to the electrical signal that is sent to the speakers via the amplifiers in real time.

The actual audio signal reproduced by the system depends on the type of speakers used and their positioning. To analyse the acoustic response, use a spectrum analyser connected to a microphone. Otherwise you need to make use of your experience in listening and refine the calibration by relying on it.



- 1. Flat / Reset:** it restores, if enabled, all the poles of the parametric equalizer in the default position.
- 2. Link L/R:** it applies, when active, the equalization curve to both the right and left channels simultaneously.
- 3. L->R R->L:** this function is active when "Link L / R" is deactivated. By clicking on one of the two keys it is possible to transfer the equalization curve of the Left channel to the Right one and vice versa.



4. **Xover:** it displays the electrical response subjected to filtering (XOVER), by clicking on the box (red curve).

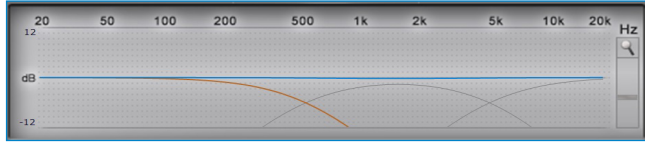

5. **EQ:** it displays the electrical response subjected to equalization, by clicking on the box (yellow curve).

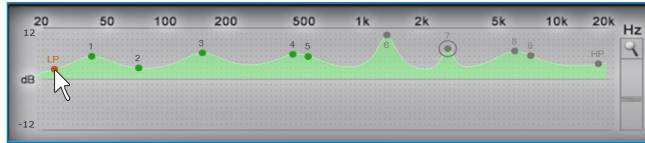

6. **SUM:** it displays the sum between the electric response and the crossover, by clicking on the box (purple curve).



7. **PH:** It allows the user to view the progress of the electrical phase. Its performance depends on the filters and the equalization applied.

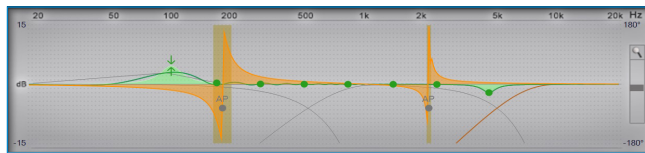

8. **EQ Off:** when active, it allows the equalizer to be switched off.

**Remark:** in order to display the set equalization curve more clearly, it is possible to increase or decrease the vertical scale (dB) by moving the cursor positioned to the right of the equalization curve diagram. By default the diagram display is set to  $\pm 12$ dB.



View example with  $\pm 3$ dB magnifier function



View example with  $\pm 24$ dB magnifier function

### 8.8.3 MAIN EQ

Selecting the "Main EQ" check the general equalization curve of the entire audio system will be displayed. The tuning of this curve must be the last operation to be performed in your setup, and has the function to best adapt the frequency response of your audio system.

By clicking on the POP UP activation icon, it is possible to display the main equalizer controls in full screen. If you do not use the POP UP mode it will always be possible to perform the system tuning but reducing the use of the equalizer functions.



#### MAIN EQ. SETTING

**A.** It is possible to change the equalizer parameters, in order to set an equalization curve via 6 Poles, of which 5 FIR (blue pole) and 1 IIR (green pole). By operating on the setup window it is possible to adjust the

**Frequency (f: 20 Hz ÷ 20KHz step min 1Hz),**

**Gain (g: -15 dB ÷ +15dB step min 0.1 dB) and the**

**Q factor (Q: 0.1 ÷ 16 step min 0.1) using the cursors.**

The curve can be manually edited using the mouse pointer. To be able to vary the "F" "G" and "Q" factors, you will just need to act on the mouse wheel equipped with this function. A finer adjustment of these parameters can also be made using only the PC keyboard.

- The keys and : allow the selection of the pole to be adjusted on the diagram. The successful selection of the pole is displayed by a circle around it.
- Key : allows the selection of the "F", "G" and "Q" poles control point. The successful selection of the control point is visible through the green color of the control slider.
- Keys + and + .

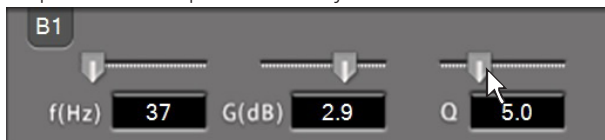

Example of IIR pole adjustment



Example of FIR pole adjustment

**B. PCM FILTER MODE:** this function operates on the internal DACs of the bit One HD Virtuoso (setting them internally  $\frac{1}{2}$  Fs); (Fs = 96KHz). It is only available on the analog outputs. By activating the AD LINK / AC Link outputs this function will not be available.

#### - SLOW ROLL OFF

Compared to the "FAST ROLL OFF" it has a less accentuated filter slope with a slightly wider bandwidth, more ripple and less filter delay.

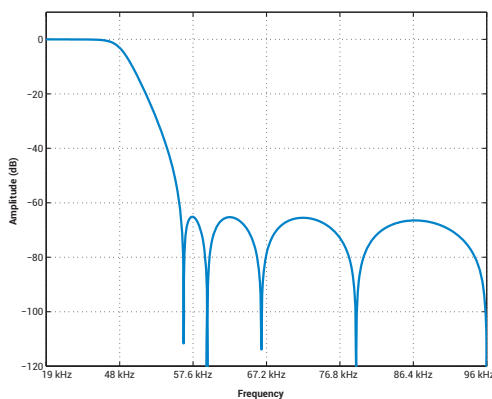

#### - FAST ROLL OFF

Compared to the "SLOW ROLL OFF" it has a more pronounced filter slope, a smaller ripple around the cut-off frequency, and the filter delay is greater.

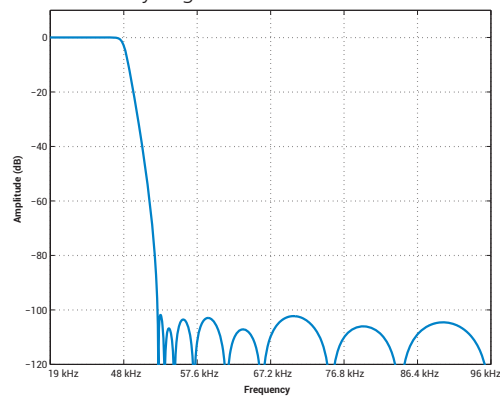

Since this filtering is outside the audio range and in the presence of other analog filters, their difference is really imperceptible and varies according to the kind of tracks you listen to, or the more or less complex structure of the audio system. The real differences can be appreciated once the Bit One HD setup is completed, where only listening tests will give reason to the most appropriate choice.

8.8.4 RTA



By enabling the equalizer pop up menu, the three main equalizers are available, as well as the RTA tool, which allows the user to quickly tune the audio system. The acquisition takes place via an audio interface connected to the PC, and a microphone to it.

In Channel EQ mode it is possible to perform a self-calibration of the front with respect to the target curves.

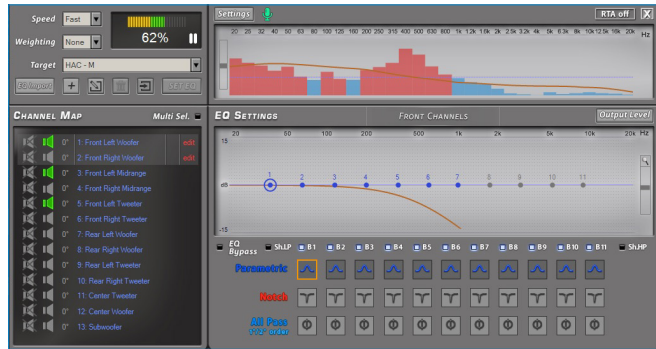

**Description:**

**A) Settings.** It allows the user to select the audio device available, connected to the PC.

**Driver:** it allows the user to select the audio capture devices connected to the PC.

**Remark:** it is possible to interface the Audison bit Tune device to the PC, which can manage both the HSM microphone and the TMD microphone. The TMD microphone compared to the HSM microphone allows greater accuracy in the measurement, while the HSM microphone allows an environmentally more accurate measurement

**Microphone Calibration File:** it allows the user to load, if available, the calibration file of the microphone connected to the audio device selected in the previous point.

The correct connection of the audio device to the PC is confirmed by the green logo. If the logo is red, check the audio interface settings or its correct connection to the PC.

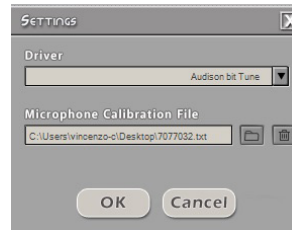
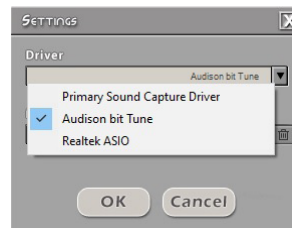

**B) Speed:** it sets the updating speed of the spectral measurement displayed for a good compromise between accuracy and ease of reading.

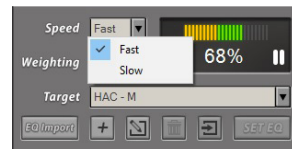

**C) Weighting:** it selects the type of weighting filter for the measurement.

**None:** excludes any weighting filter in signal acquisition. It expresses the absolute value but does not take into account the acoustic perception of the human ear.



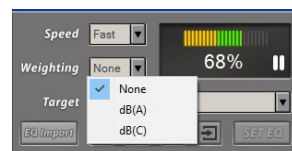

**A-weight:** Suggested. It enables an A-type weighting filter. It inserts a filter that simulates the perception of the human ear with a low background noise. It is the curve used for the signal to noise ratio measurements (S/N Ratio).

**C-weight:** it enables a C-type weighting filter. It is used with high-level background noise

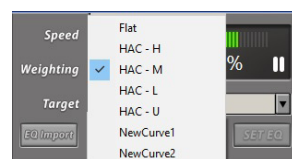

**D) Target:** it allows the user to load an arrival curve of the final result after having acquired the environmental response of the passenger compartment. The default curve provides the ability to achieve an optimal listening ambience, which can then be manually adjusted by interacting on the front equalization with the parametric equalizer.



- E) **EQ import:** it allows the user to import an equalization curve into the Front equalizer generated by third-party programs (Rew.....)
- F)  To edit a new target curve and then save it.
- G)  To edit an existing target curve and then save it.
- H)  To delete an existing target curve.
- I)  To load an existing target curve.
- J)  After an RTA acquisition, it allows the automatic equalization of the emission front of the selected system.
- K) **Measurements:** the display to the right shows the commands for the acquisition level of the RTA level indicated by a colored bar and a numerical percentage value. To acquire the signal, select the front speakers (Front Left is selected by default), play pink noise and then press the Play button. Reach a signal level between 60 and 80% using the volume control of the Virtuoso and then press pause. At this point you can select the "Set EQ" button and proceed with the automatic equalizer setup. The result of the automatic equalization depends on the Target curve and its positioning with respect to the acquired curve (see next point).

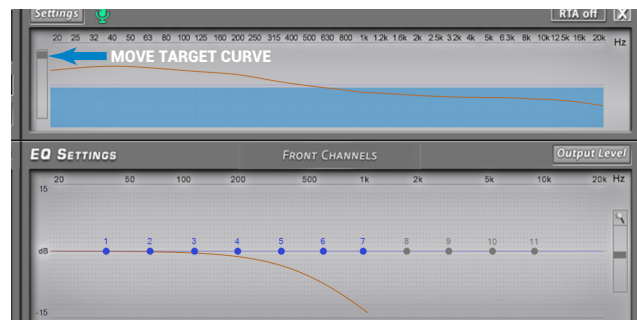
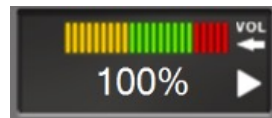
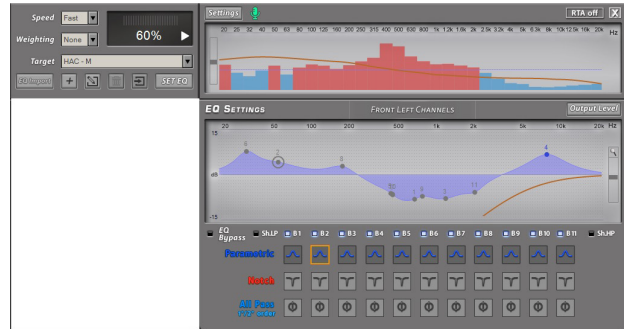

## 8.9 OUTPUT LEVEL 9

This section shows the settings of the output levels of the bit One HD Virtuoso active channels as displayed by the software.

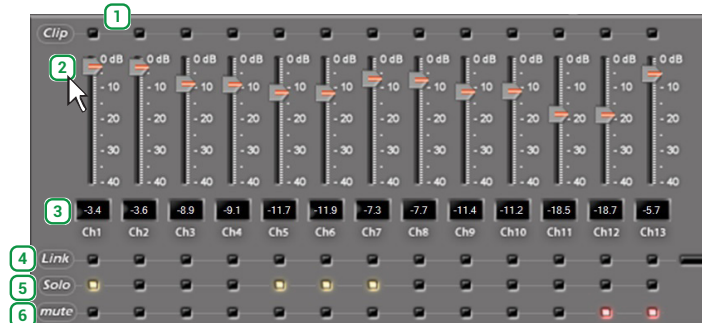

Following please note the description of each of the functions marked with numbers in the image above.

- 1 When "**Clip**" lights up in red, it means clipping is occurring on the output channel. When this occurs, you will just have to decrease the output level of the corresponding channel or decrease the equalization previously set up. If the "**Limiter**" function has been applied to the clip the led light will be orange
- 2 By acting on one of the sliders belonging to the output channels, the output level (- 40 ÷ 0 dB) for each channel can be adjusted.
- 3 This area of the screen shows the output level of each single channel (- 40 ÷ 0 dB), compared to the slider position of the output channels.
- 4 By selecting "**Link**", all the bit One HD Virtuoso output levels can be adjusted simultaneously. By selecting "**Link**" again the function will be disabled
- 5 By selecting "**Solo**" the output levels will be muted except the active one. By selecting "**Solo**" again this function will be disabled.
- 6 The selection of the "**Mute**" button provides the ability to mute the corresponding output channels. By selecting "**Mute**" again, the mute function will be disabled

**Remark:** if the installation includes a mono Subwoofer, the sensitivity of its dedicated amplifier needs to be increased by +3 dB compared to rest of the amplifiers (see the "Amplifiers Sensitivity" diagram). This empirical method considers many aspects and will provide an improved adjustment capability of the "Subwoofer Level".

**Amplifiers Sensitivity (Volts)**

Front/Rear	1.0	2.0	3.0	4.0
<b>Sub (+3 dB)</b>	0.7	1.4	2.1	2.8

**Important Remark:** the output level adjustment (2) affects the system signal / noise ratio (**whistle / background hiss**). We recommend that you always set the bit One output at high level and the amplifiers' sensitivity at low level, so the amplifiers will be less sensitive to background noises/hisses. An excessive output level causes the clipping led lights to turn on (1), especially if equalizations with high gain are applied. Therefore we recommend that you proceed as follows:

- a) Adjust the amplifiers sensitivity level to the minimum value (3-4V RMS).
- b) Balance the emission level of the system channels by moving the sliders (2) paying attention to maintain a centered mid level at around -20 dB. Turn the output volume to an acceptable listening volume level.
- c) Set the desired output equalizations ([see sec. 8.9](#)).
- d) Insert a CD playing a highly dynamic track.
- e) Select the "**Link**" function (5), move the slider and increase the output channels level until one of the "clipping" led lights turns on (1); move the slider back of at least 2-3 dB (check the value on one of the displays (3)).
- f) Increase the "**Master Volume**" (6) up to the maximum undistorted level taking it close to "0" dB.
- g) In case the signal is highly distorted with the "**Master Volume**" at "0" dB, the output levels (2) will need to be decreased or enable the "**Limiter**" function. If, on the contrary, no distortion occurs, the amplifiers' sensitivity will have to be increased until the first distortion symptoms appear: by doing this, you will make the most of all the available power.

**Remark:** this procedure leads the user to calibrate the system at "zero dB undistorted". This is not always the best solution, since, if you listen to a track that has been recorded at a lower level or with lower dynamics than the track used for the setup, a loss in dynamics may occur. So a good compromise needs to be found, depending on the listener preferences.

**8.10 VOLUME LEVEL** 10

This section shows the settings related to the output level of the Master Volume and Sub Volume of the bit One HD Virtuoso.

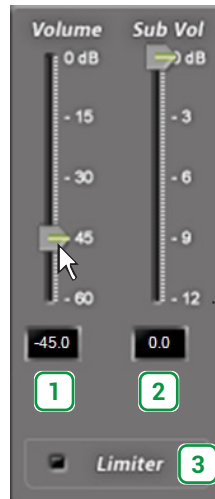

- 1 By acting on the **"Master Volume"** function, you can adjust the system general volume (-60 ÷ 0 dB).
- 2 The **"Subwoofer Level"** function allows for the subwoofer output level adjustments (-12 ÷ 0 dB), when the system features a subwoofer.
- 3 The **"Limiter"** function enables the limiter on bit One HD Virtuoso output level. This function is essential to avoid the occurrence of temporary clipping, causing the outputs saturation. By selecting **"Limiter"** again, the function will be disabled.

**8.11 SELECT INPUT** 11

The "Selected Input" window will display the active source during the connection with the PC. Auxiliary sources can be added or removed entering the **Config->Auxiliary Inputs** menu and selecting the desired source ([see section 8.3.3](#)). Once you will have disconnected from the PC, the bit One H D input source can be selected via DRC MP.

**Sensitivity:** to perform the setting/display of the analog inputs. Click on the icon for the **Input Setup**.

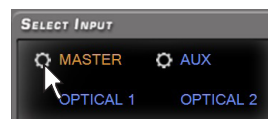

To perform the sensitivity adjustment, refer to [section 8 of this user manual](#).

To change the input signal levels manually, once the manual calibration has been performed, you have two options:

- a) Click on the + 3dB / + 6dB buttons to increase the input signal by 3dB / 6 dB.
- b) Select the Link check box, keeping the Ref check active, so as to calibrate the input signal levels.

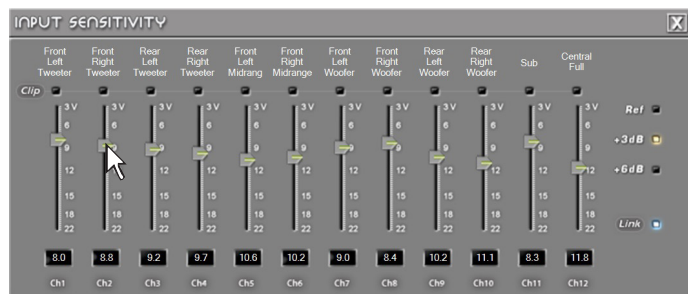

**8.12 SETUP** 12

**1. PERCEPT MPC:** this function is enabled/disabled when a calibration is performed using the bit Tune software. The equalization applied is displayed on screen and the frequency response can be adjusted by 5 poles.

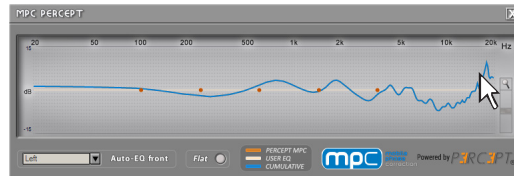
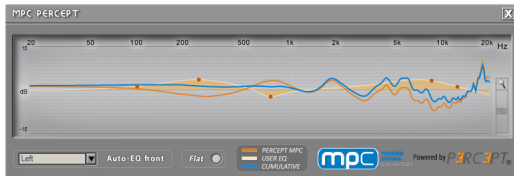
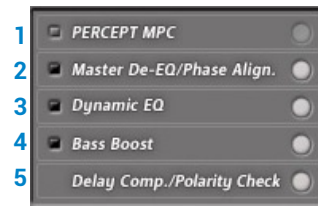

**2. Master De-EQ/Phase Align.:** by selecting this menu it is possible to view the progress in Module and Phase of all the Head Unit fronts (see sec. 7.2.2.7).

**MODULE**

- Selecting the **De-Eq on/off** button, you can enable or disable the de-equalization applied to the Head Unit connected to the bit One HD Virtuoso.

- Selecting the **Wizard** button, it is possible to carry out a new configuration session to set the sensitivity levels of the source and check whether the source is equalized or not (see sec. 7.2.2.6).

- by clicking on the **"Suggested AP Filter Set"** key, it is possible to Enable or disable the correction of the phase applied to the Head Unit Connected to the bit One HD Virtuoso detected during the analysis performed. The graphic interface will show the fronts related to the All-Pass filters application (Front L-R, Rear L-R, Center), and a chart where the fronts electric result selected from the menu will be displayed. If a phase analysis was performed during the phase "Configuration Wizard" procedure (see sec. 7.2.2.7), the compensation points suggested by the analysis will be displayed. They can be fine tuned thanks to the electric result and listening sessions. If the automatic phase analysis procedure has not been performed, the All-Pass control points will be present but no position for compensation will be recommended.

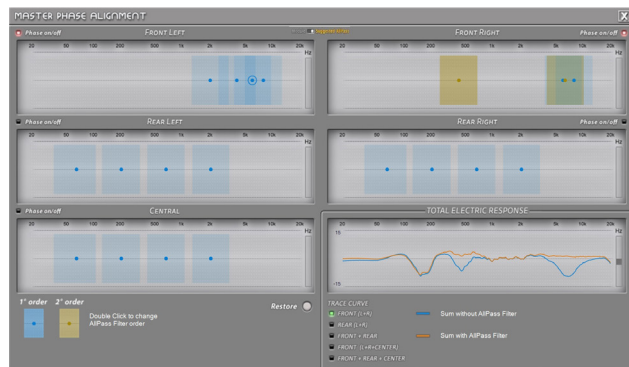
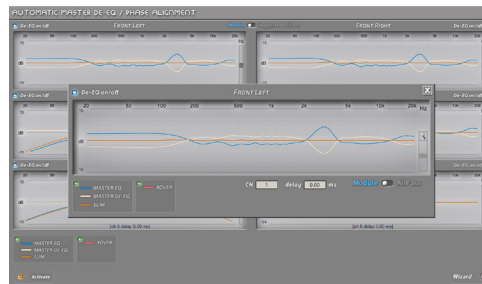

**All-Pass Filter type:**

There are two types of All-Pass filters, 1st and 2nd order. Their selection is done by double clicking with the mouse pointer, which will highlight the area with a different color depending on the type selected. First order filters are light blue, while second order filters are yellow. Their activation is displayed by the transition from a point to a well-highlighted intervention area that occurs by setting the phase other than 0°.



**All-Pass Filters Setting**

**Frequency:** by moving the point to adjust with the mouse pointer (f: 20 Hz ÷ 20KHz).

**Phase:** **CTRL** + **←** and **CTRL** + **→** allows the change of the Phase control at 1 degree Steps. For 1st order All-Pass the adjustment ranges from 0-180° while for 2nd order All-Pass the adjustment ranges from 0 -360°.

**Q:** **CTRL** + **↑** and **CTRL** + **↓** allows the change of the Q factor at 0.1 Steps (just for 2nd order All-Pass).

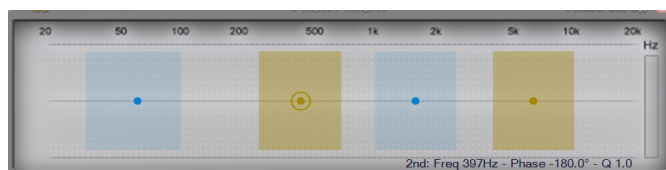

**Total Electric Response.**

The chart shows the electrical sum of the channels selected in the menu "Trace Curve". If a "Phase Analysis" was performed (see sec. 7.2.2.6), two curves will be displayed. The Blue curve refers to the trend of the selected fronts, where the presence of All-Pass filters can be shown, provided by one or more holes in the frequency domain, while the orange color refers to the fronts compensation via All-Pass filters. If the Phase Analysis was not performed, only the orange curve resulting from the modifications made via All-Pass adjustment will be displayed.

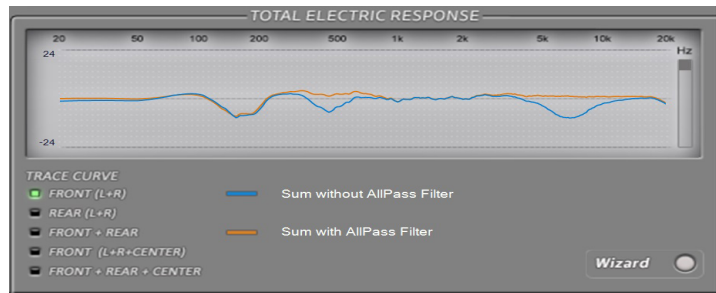

**Phase ON/OFF**

By clicking on the Phase on/off key, it is possible to enable or disable the correction of the phase applied to the Head Unit connected to the bit One HD Virtuoso. The activation is successful when the led light becomes red.



**Restore Phase Alignm suggestions:**

If an "AUTOMATIC MASTER DE-EQ / PHASE Analysis" was performed and new valued are then edited, it will be possible to restore the phase compensation values suggested by the software (see sec. 7.2.2.7).



**3. Dynamic EQ:** the sound of an audio system may vary according to the reproduction volume. At low volume, the noises coming from outside the vehicle and the especially insulated acoustic within the car compartment contribute to limit (especially in low frequency) the system's performance. Generally during calibration you need to consider that the adjustments performed with low level volume may change relentlessly when the volume will be increased.

The **Dynamic Equalization** improves the listening actively operating on the variation of the frequency response as a consequence to the volume change. The Wizard will suggest a series of windows to set up the equalization to be applied to the general frequency response. The bit One HD Virtuoso will automatically perform a gradual data interpolation, following the signal level and therefore acting according to the system volume. Two operating modes are available. To use this function click on the button to the left of the menu until the orange led lights up. To disable the function click again on the button until the orange led turns off.

**Reference.** The dynamic equalizer can be adjusted in two ways:

**DRC VOLUME:** the trend of the dynamic equalization curve depends on the Virtuoso master volume level set via DRC.

**Input Signal:** the trend of the dynamic equalization curve depends on the Virtuoso input level. You can choose whether to apply this curve either to the Master input or to the auxiliary inputs (Analog Aux, Optical 1/2).

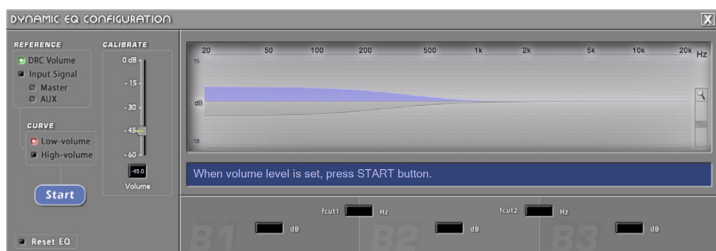

**SETUP**

To set up the dynamic equalizer click on the button to the right of the menu and proceed as follows:

Insert a CD in the source and play a reference track. A semi-automatic procedure will start. Move the Volume slider setting the low volume listening reference level. After adjusting the slider, select **START**.

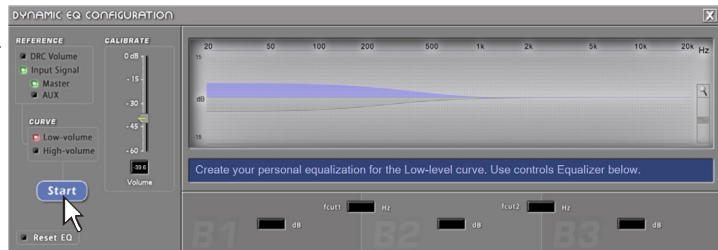

Move the **EQ** slider to set up the low volume response equalization until the desired sound is achieved. In this case the equalization curve which applied is pre-set. When reaching the desired setting select **SAVE**. At this point the reference curve for low volume listening will be applied.

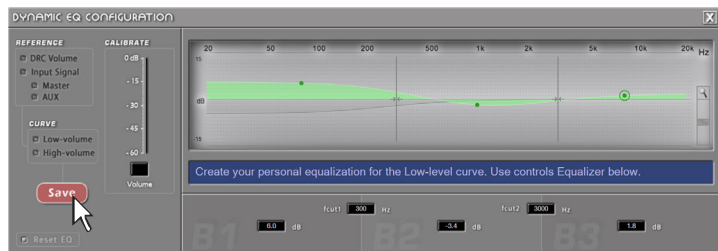

The semi-automatic procedure continues requesting the set up of the high volume listening reference level. Move the Volume slider to the desired level. After adjusting the slider, select **START**.

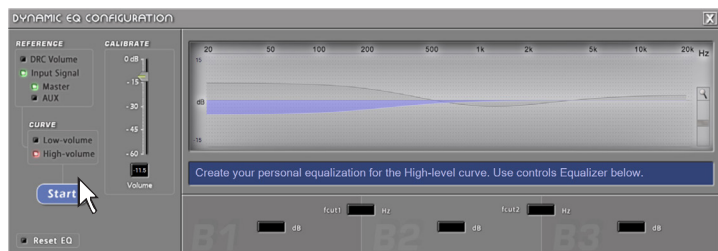

Move the **EQ** slider to set up the high volume response equalization until the desired sound is achieved. After finding the right adjustment select **SAVE**. At this point the reference curve for high volume listening will be applied.

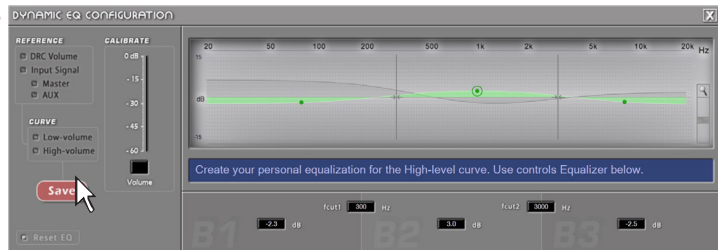

**Reset Dynamic EQ**

During the setup the Reset EQ button can be selected to reset the applied modifications and restore the default values.



To confirm the settings and activate the Dynamic Equalizer while listening click on the X of the PC software window.

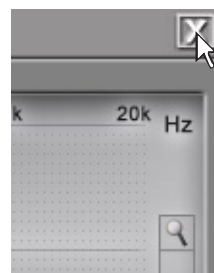

At a later stage, besides being enabled and disabled via PC software, this function can also be enabled/disabled via DRC MP.

**4. Bass Boost:** this function, if enabled, has the purpose of intervening on the equalization of the sub channel and the woofers, applying an equalization on the low frequencies.

This function can be used in two operating modes: Fixed and Dynamic. In Fixed mode the application of the equalization is static, while in dynamic mode it involves the application of the curve according to the level of the input signal.

**- Fixed Mode**

By selecting Fixed it is possible to choose the parametric equalization pole on which to intervene and vary the "Q" factor by using the mouse wheel if equipped with this function. In order to operate on the parametric equalizer it is also possible to use the setup window (shown to the side), where you can intervene in more detail on the following parameters:

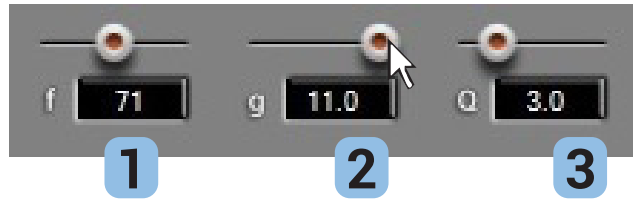
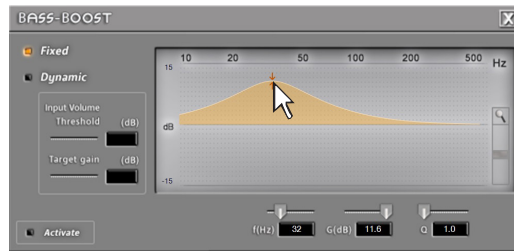

- 1.frequency of intervention.
- 2.parametric pole gain.
- 3.Q factor.

To **enable** the function, click on the button located on the left of the menu, until the orange LED lights up.

To **disable it**, click again on the button until the orange LED turns off. The function can also be enabled and disabled from the DRC MP.

**- Dynamic Mode**

By selecting Dynamic it is possible to choose the parametric equalization pole on which to intervene and vary the "Q" factor by using the mouse wheel if equipped with this function. In order to operate on the parametric equalizer it is also possible to use the setup window (shown to the side), where you can intervene in more detail on the following parameters:

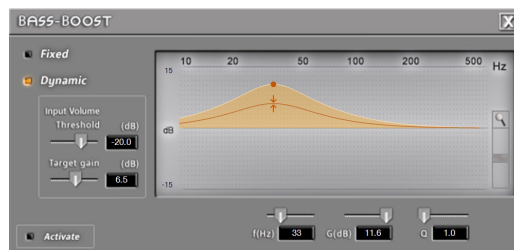

- 1.frequency of intervention.
- 2.parametric pole gain.
- 3.Q factor.

**Threshold:** minimum intervention threshold of the maximum boost application level.

**Target Gain:** minimum boost intervention threshold.

To **enable** the function, click on the button located on the left of the menu, until the orange LED lights up

To **disable it**, click again on the button until the orange LED turns off. The function can also be enabled and disabled from the DRC MP.

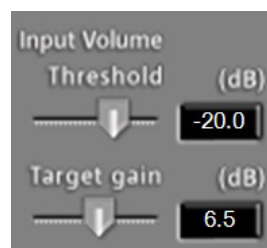

**5. Delay Comp./Polarity Check:** this function shows the result of the analysis performed during the "I / O CONFIGURATION WIZARD" concerning the presence of time delays, possible compensation and the result of the correct electric connection of the wiring to the inputs of the bit One HD Virtuoso.

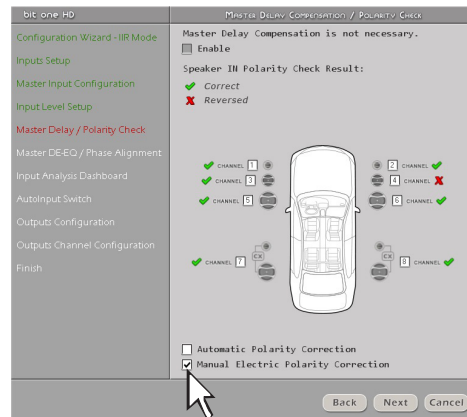

**8.13 DEVICE INFO**

13

This window shows whether the **bit One HD Virtuoso** is properly interfaced with the PC and the DRC MP. It also shows the Firmware version for the device and the Serial Number.

The background of the device info assumes two colors:

- Blue background: IIR setup.
- Green background: FIR setup.



Device Info IIR mode

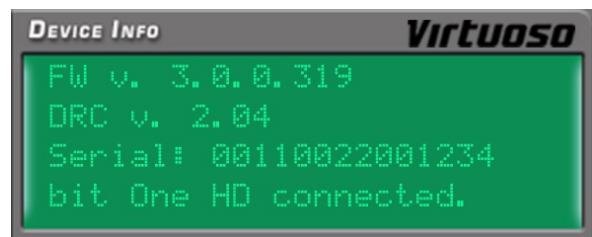

Device Info FIR mode

## 9. TROUBLESHOOTING

### 9.1 SYNCHRONIZATION WITH THE PC

#### 1. bit One HD Virtuoso functioning problems

- If, while tuning the system with a laptop PC connected to the bit One HD Virtuoso, should present any functioning problems, try to disconnect the laptop PC power supply cable. In this way, with the laptop PC working on battery power, a possible voltage difference in the USB ground connection between the car (bit One HD Virtuoso) and ground (PC) can be avoided.

#### 2. bit One HD Virtuoso does not connect to PC software

- If, while tuning the system with the PC connected to the bit One HD Virtuoso, the device is switched off and then on again, the connection is lost and the software can not "finalize" the selected setup. If you don't want to lose the modifications and setup previously selected, proceed as follows:
  - a- save the setup as a file on the PC using the function: FILE / SAVE SETUP;
  - b- exit the software;
  - c- turn on the bit One HD Virtuoso;
  - d- launch the software again;
  - e- load the setup file again using the function: FILE / LOAD SETUP

#### 3. bit One HD Virtuoso does not respond

- If, while tuning the system with the PC connected to the bit One HD Virtuoso, the device does not respond, proceed as follows
  - a- turn the bit One HD Virtuoso off:
    - by DRC MP, or
    - disconnecting the Remote IN, or
    - disconnecting the power supply cable for a few seconds;
  - b- save the setup as a file on the PC using the function: FILE / SAVE SETUP;
  - c- exit the software;
  - d- turn on the bit One HD Virtuoso;
  - e- launch the software again;
  - f- load the setup file again using the function: FILE / LOAD SETUP.

#### 4. Settings not saved

- In order to successfully complete the bit One HD Virtuoso setup phase and not lose the settings performed, remember to save the selected settings. Select File from the main software menu via the PC and then choose "Finalize to **bit One HD Virtuoso**".

### 9.2 BACKGROUND NOISE

#### Loud whistle /background hiss

In case a loud whistle / background hiss can be heard, it may be necessary to repeat the input sensitivity auto-setup and / or to rectify the output levels adjustment. For more information, [see sections 7.2](#).

### 9.3 FIRMWARE UPGRADES



If there are product UPGRADES available online, proceed as follows

- Save the previous setup (if you wish to consult it in OFFLINE mode)
- Disconnect the bit One HD Virtuoso "Pre Out".

Start the bit One HD Virtuoso PC software and select TARGET mode.

1. Access the "**File**" menu in the PC management software and choose "**Check for Updates**".
2. When you select "Check for Updates", the internet browser in the PC will open up and will automatically search for the **URL: [www.audisonbitdrive.eu](http://www.audisonbitdrive.eu)**. Once the related page is open, click on the LINK for the product.

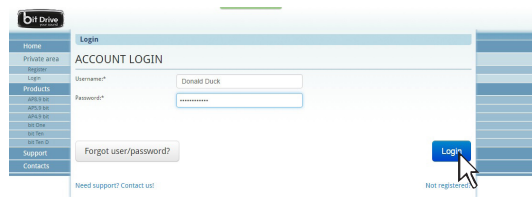

- Identify the newest file whose name includes the word Firmware followed by four numbers and click on the specific symbol to start the download. When requested, save the file to the PC.
- Select "**Update Firmware**". The program will ask you to select the file that was just saved from the Download Area or that was previously saved in the PC.

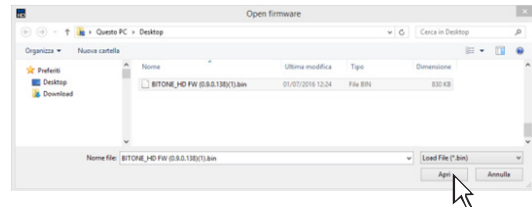

**WARNING:** the bit One HD Virtuoso Firmware update procedure may be delicate. It is extremely important that it is performed under the best possible conditions.

If the operation is started and prematurely interrupted (e.g.: PC locked up, loss of power to the bit One HD Virtuoso, accidental disconnection of the USB cable during update), our After Sales Service might need to be contacted to reprogram the **bit One HD Virtuoso**.

- Before starting the bit One HD Virtuoso update, the program warns you to:
  - not disconnect the bit One HD Virtuoso from the PC;
  - not disconnect the bit One HD Virtuoso from power;
  - temporarily disable the PC automatic stand-by processes;
  - temporarily disable the screen saver on the PC;
  - close all running applications;
  - temporarily disable the anti-virus and anti-spyware systems.

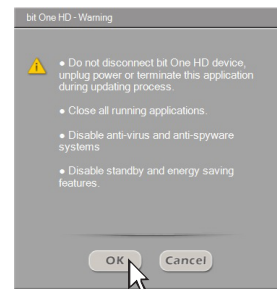

- Once you have clicked on **OK**, the Firmware update procedure starts. This process will last between 30 seconds and 1 minute; the progress bar and the flashing logo on the bit One HD Virtuoso will show the updating process status.

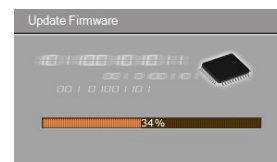

**WARNING:** during the update, the progress bar may stop for a few seconds. Do not interrupt the process in any way.

The performed update is displayed on the dialog window. To use the bit One HD Virtuoso again, close the program on the PC and turn off the bit One HD Virtuoso.

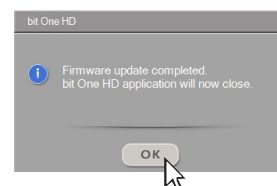

- Turn bit One HD Virtuoso back on and restart the PC software. If bit One HD Virtuoso firmware update has been completed correctly, the dialog window will display the following:
  - new bit One HD Virtuoso Firmware version.
- Repeat the product calibration operations ([see sec. 7.2](#)).

## 9.4 RESCUE MODE

If there are product UPGRADES available online, proceed as follows:

- save the previous setup (if you wish to consult it in OFFLINE mode);
  - disconnect the bit One HD Virtuoso "Pre Out".
  - disconnect the bit One HD Virtuoso terminal block.
  - place the Upgrade Mode switch to "ON" position.
  - connect the bit One HD Virtuoso terminal block.
- The logo on the product starts flashing.

Start the bit One HD Virtuoso PC software and select "RESCUE MODE".

1. Access the "File" menu in the PC management software and choose "Check for Updates".
2. When you select "Check for Updates", the internet browser in the PC will open up and will automatically search for the URL: [www.audisonbitdrive.eu](http://www.audisonbitdrive.eu). Once the related page is open, click on the LINK for the product.
3. Identify the newest file whose name includes the word Firmware followed by four numbers and click on the specific symbol to start the download. When requested, save the file to the PC.
4. Select "Update Firmware". The program will ask you to select the file that was just saved from the Download Area or that was previously saved in the PC.

**WARNING:** the bit One HD Virtuoso Firmware update procedure may be delicate. It is extremely important that it is performed under the best possible conditions.

If the operation is started and prematurely interrupted (e.g.: PC locked up, loss of power to the bit One HD Virtuoso, accidental disconnection of the USB cable during update), our After Sales Service might need to be contacted to reprogram the **bit One HD Virtuoso**.

5. Before starting the bit One HD Virtuoso update, the program warns you to:
  - not disconnect the bit One HD Virtuoso from the PC;
  - not disconnect the bit One HD Virtuoso from power;
  - temporarily disable the PC automatic stand-by processes;
  - temporarily disable the screen saver on the PC;
  - close all running applications;
  - temporarily disable the anti-virus and anti-spyware systems

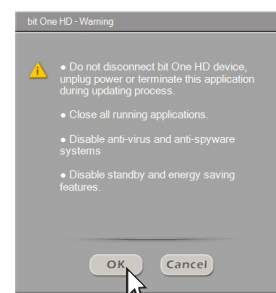
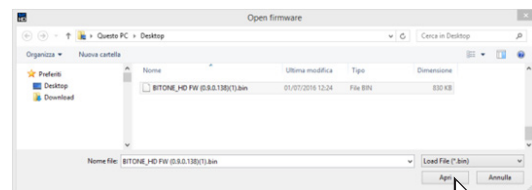
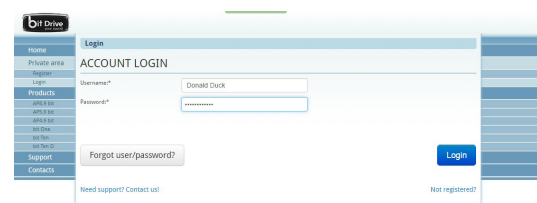
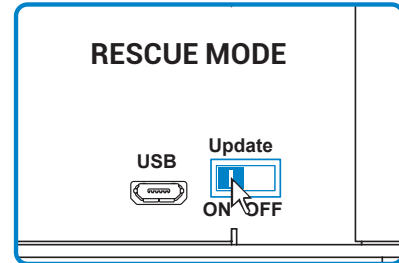

6. Once you have clicked on OK, the Firmware update procedure starts. This process will last between 30 seconds and 1 minute; the progress bar and the flashing logo on the bit One HD Virtuoso will show the updating process status.

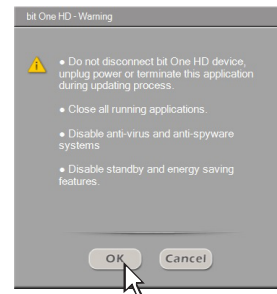

7. Place the "UPGRADE" switch to OFF position.
8. Disconnect and the connect again the bit One HD Virtuoso terminal block.
9. Turn bit One HD Virtuoso back on and restart the PC software. If bit One HD Virtuoso firmware update has been completed correctly, the dialog window will display the following:
  - new bit One HD Virtuoso Firmware version.
10. Repeat the product calibration operations ([see sec. 7.2](#)).

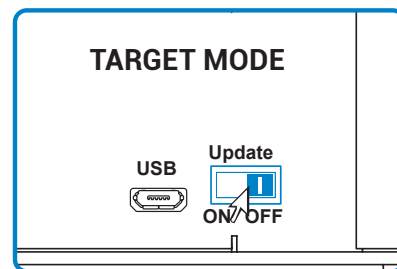

## 10. TECHNICAL SPECIFICATIONS

### POWER SUPPLY

Nominal power supply voltage / Fuse	11 ÷ 15 VDC / 2A
Pulse operating voltage	6,5 ÷ 17 VDC
Idling current	0.75 A
Switched off without DRC	2 mA
Switched off with DRC	5 mA
Remote IN	4 ÷ 15 VDC (1 mA)
Remote OUT voltage	4 ÷ 15 VDC (130 mA)
ART - Automatic Remote Turn on/off from OUTPUT BTL speakers	1.5 ÷ 7 VDC

### SIGNAL STAGE

Distortion - THD @ 1 kHz, 1 VRMS Output	0.004 %
Bandwidth @ -3 dB	10 Hz ÷ 44 kHz
S/N ratio @ A weighted 4 V Output, 2 V MASTER input	104 dBA
S/N ratio @ A weighted, 4 V Output, 2 V AUX input	105 dBA
S/N ratio @ A weighted, 4 V Output, OPTICAL IN1/IN2 input	110 dBA
Channel Separation @ 1 kHz	80 dBA
Input sensitivity Pre IN / Master	1.3 ÷ 9 VRMS
Input sensitivity Speaker IN / Master	5 ÷ 32 VRMS
Input sensitivity AUX	0.7 ÷ 5 VRMS
Input impedance Speaker IN / Aux / Pre In	15 kΩ (Pre IN / AUX) 5 Ω (Speaker IN)
Max Output level 0,1% THD	4 V

### INPUT STAGE

Low level (Pre)	Ch1 ÷ Ch6; AUX L/R
High level (Speaker In)	Ch1÷Ch12
Digital	2 x Optical S/PDIF; Max 192 kHz / 24 bit

### OUTPUT STAGE

Low level (Pre)	Ch1 ÷ Ch13 (IIR mode); Ch1 ÷ Ch9 (FIR mode)
Digital AD Link 1	Ch1 ÷ Ch8 (IIR / FIR mode)
Digital AD Link 2	Ch9 ÷ Ch13 (IIR mode); Ch9 only (FIR mode)

### CONNECTION

From / To Personal Computer	1 x micro USB
To Audison Amplifiers	2 x (AC Link/AD LINK) control bus
To Audison DRC	1 x AC Link

### CROSSOVER

Filter type	Full / Hi pass / Low Pass / Band Pass
Filter mode and slope	Linkwitz @ 12 / 24 / 36 / 48 dB Butterworth @ 6 / 12 / 18 / 24 / 30 / 36 / 42 / 48 dB Bessel @ 6 / 12 / 18 / 24 / 30 / 36 dB FIR @ 6 / 12 / 18 / 24 / 30 / 36 / 42 / 48 dB
Crossover Frequency	Lo-Pass: 0 ÷ 44k Hz (1 Hz step) Hi-Pass: 0 ÷ 20k Hz (1 Hz step)
Phase control	0° / 180°

### EQUALIZER (10 ÷ 20K Hz)

High level Inputs (Speaker In)	Automatic De-Equalization, Delay Compensation, All Pass Compensation, Polarity check
AUX Input	Parametrics Equalizer: +12 dB ÷ -15 dB; 10 poles FIR type
OPTICAL IN1/IN 2 Inputs	Parametrics Equalizer: +12 dB ÷ -15 dB; 10 poles FIR type
OUTPUTS	<b>IIR mode:</b> N.13 Parametrics Equalizers: +12 dB ÷ -15 dB; 13 poles <b>FIR mode:</b> N.13 Parametrics Equalizers: +12 dB ÷ -15 dB; 9 poles FIR type + 3 poles IIR type
MAIN EQ	Parametric Equalizer: +12 dB ÷ -15 dB; 5 poles FIR type + 1 pole IIR type
Dynamic Equalization	Self-adjusting System between low and high listening levels
Bass Boost	Adjustable parametric pole (±12 dB; 10 ÷ 500 Hz)

### TIME ALIGNMENT

Distance	1,4 ÷ 756 cm / 0,6 ÷ 297,7 inches
Delay	0 ÷ 22 ms
Step	0.04 ms, 1.4 cm, 0.6 inch

### GENERAL REQUIREMENTS

PC connections	USB 1.1 / 2.0 / 3.0 Compatible
Software/PC requirements	Microsoft Windows (32/64 bit): Vista, Windows 7, Windows 8, Windows 10
Video Resolution with screen resize	min. 800 x 600
Ambient operating temperature range	0 °C to 55 °C (32°F to 131°F)

### SIZE

W (Width) x H (Height) x D (Depth) mm / inch	148 x 43.6 x 233 / 5.82" x 1.7" x 9.17"
Weight kg / lb	1.775 / 3.9

**EMC A CLASS. WARNING:** This equipment is compliant with Class A of CISPR 32. In a residential environment this equipment may cause radio interference.

## 11. ADDENDUM

### 11.1 USE OF THE KEYBOARD TO ADJUST THE BIT ONE HD SETTINGS



#### 1. Equalizers

Use of keyboard shortcuts to use Equalizer tuning. Select an equalizer among Input EQ, Channels EQ, Main EQ.

Equalizer ZOOM

and Equalizer pole selection.

Selection of the "F","G","Q","Phase" pole control point to be adjusted

+ and + To vary by 1 step the control point selected.

Reset of the values of the pole selected.

#### 2. Master Input All Pass

Use of keyboard shortcuts to set the All Pass poles. Select a Master input front and use the mouse to select an adjustment pole. It will be possible to choose first order (default) and second order All Pass poles with a double click of the mouse.

1<sup>st</sup> Order All Pass adjustment:

and Selection of the available pole.

+ and + To vary by 1° step the pole phase (0, -90°).

Reset ALL PASS pole.

2<sup>nd</sup> Order All Pass adjustment:

and Selection of the available pole.

+ and + To vary by 1° step the pole phase (0, -180°).

+ and + To vary by 0.1 step the Q value (All Pass pole area).

Reset ALL PASS pole.

### 3. Filters /Delay

Use of keyboard shortcuts to use the Filter tuning.  
Select a field within the Filter Settings:

  Adjust the fields Filter Type, Filter Model, Lo-P, Hi-P Slope, Set Distance, Delay (minimum step).

### 4. Levels

Use of keyboard shortcuts to adjust output Levels.  
Select a level Slider:

  Adjust Volume Master, Volume Sub, Volume Channels Output levels.

### 5. Resize window

The use of these quick commands automatically resizes the PC Software window.

 +  Automatic resize of PC Software window.

## 11.2 ACOUSTICS RTA VIA bit Tune

To proceed with this operation it is necessary to have calibrated the amplifiers sensitivity level ([see sec. 7.2](#)).

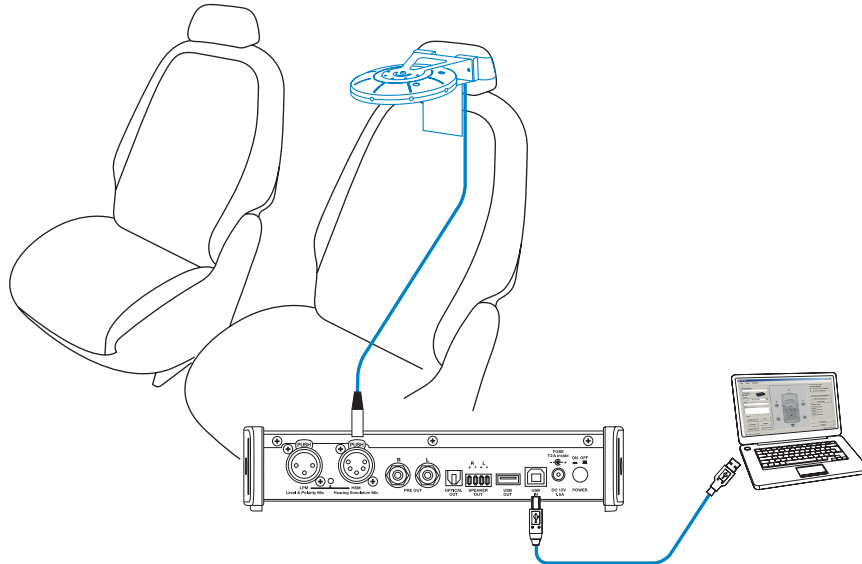

1. Turn the bit Tune on and connect the USB cable to the PC.
  - Set the function switch of the bit Tune on PC ANALYZER and Turn on the Audison bit processor and connect the USB cable to the bit Tune.
  - Start the bit Tune software by clicking the icon on the PC desktop and launch the software in bit Tune + Processor mode.
2. Select the RTA function from the "Tools" menu of the PC software or click on RTA from the main menu.

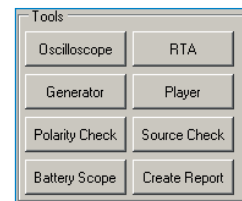

3. - Set the resolution speed by the Speed menu on "Medium".
  - Set the acquisition weighing by the Weight -> A-weight menu.

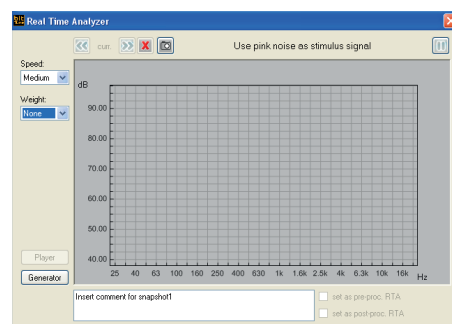

4. - Insert the setup CD into your source and start the Pink Noise track and activate the repeat function.

At this point we must intervene using the equalizer of our processor, acting on the eq. phases.

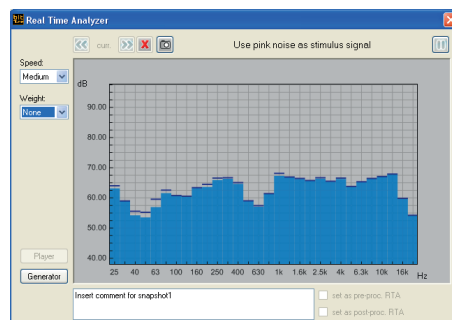



[audison.com](http://audison.com)

**audison**  
ISTINTO  
INNOVATIVO

**PART OF ELETTROMEDIA**  
62018 Potenza Picena (MC) Italy  
T +39 0733 870 870 - F +39 0733 870 880  
[www.elettromedia.it](http://www.elettromedia.it)